



LEGENDS OF  
**CHIMA**

70003





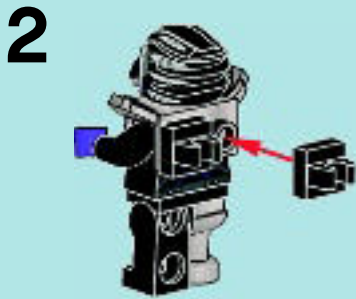
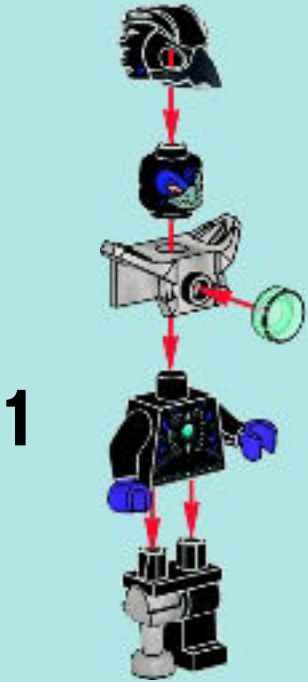
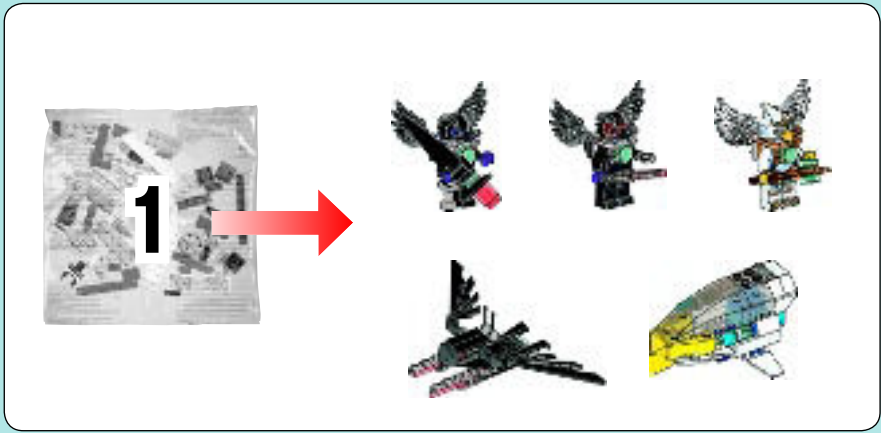



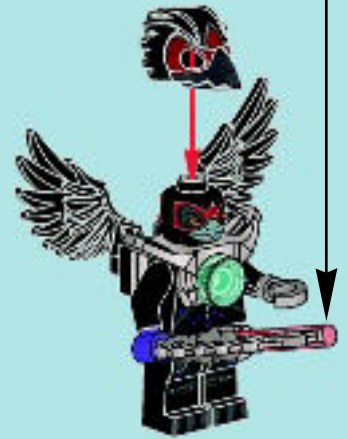
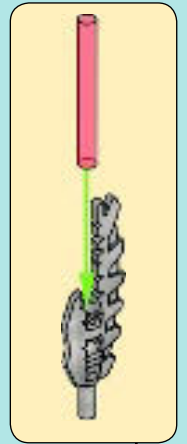
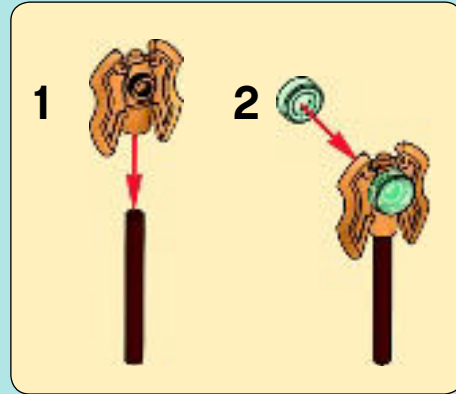
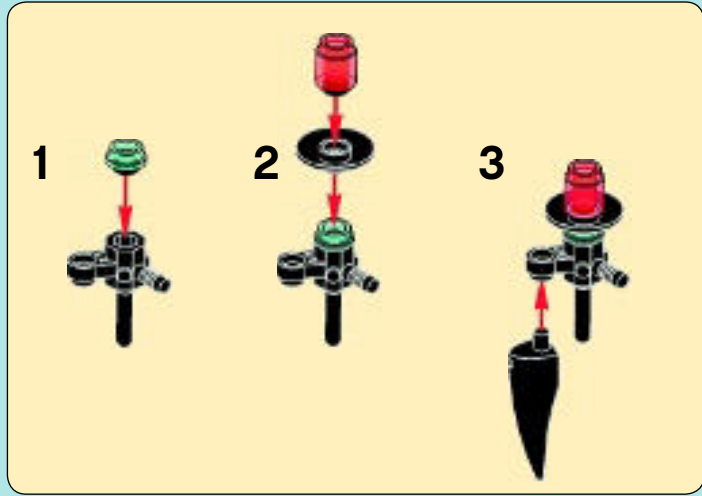

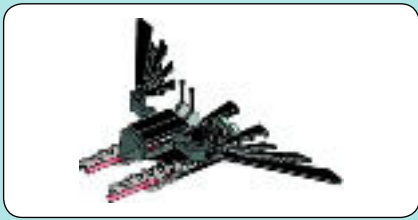

**1**

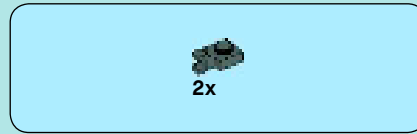

**2**

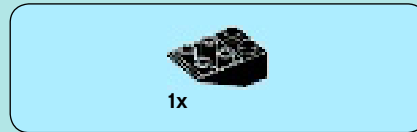

**3**





2x

4



1x

5



1x

6





1x

7

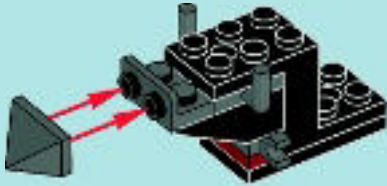

2x

8

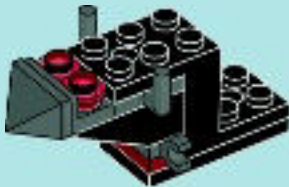

2x

9





10

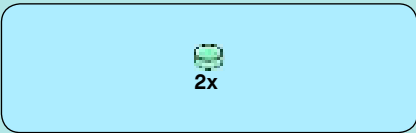
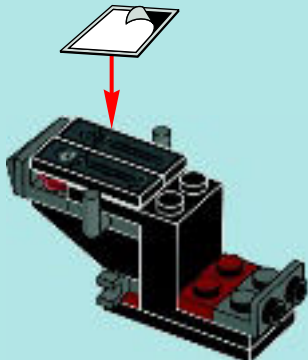

11

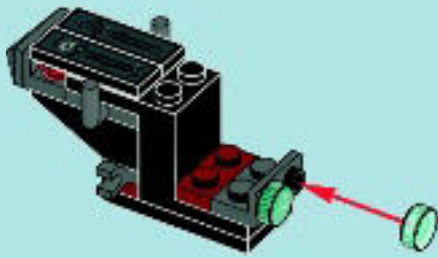

12

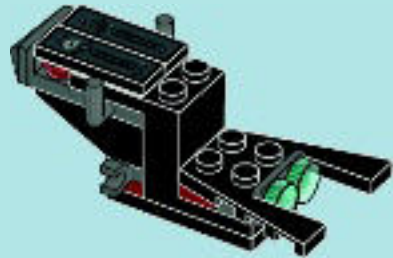





2x

# 13

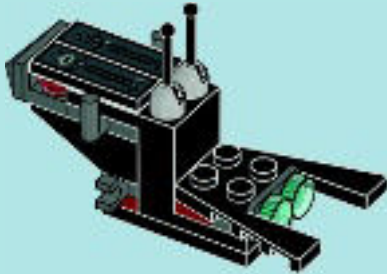

2x

2x

# 14

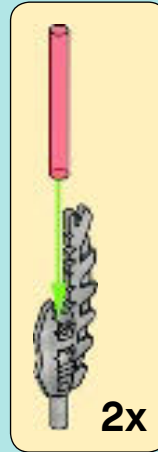

2x



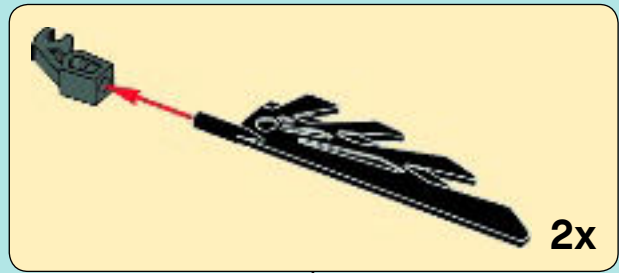
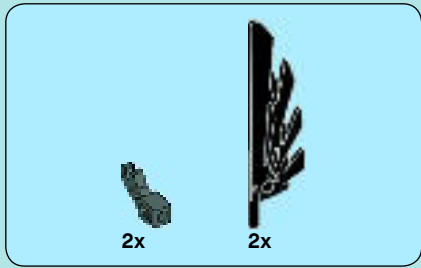

15

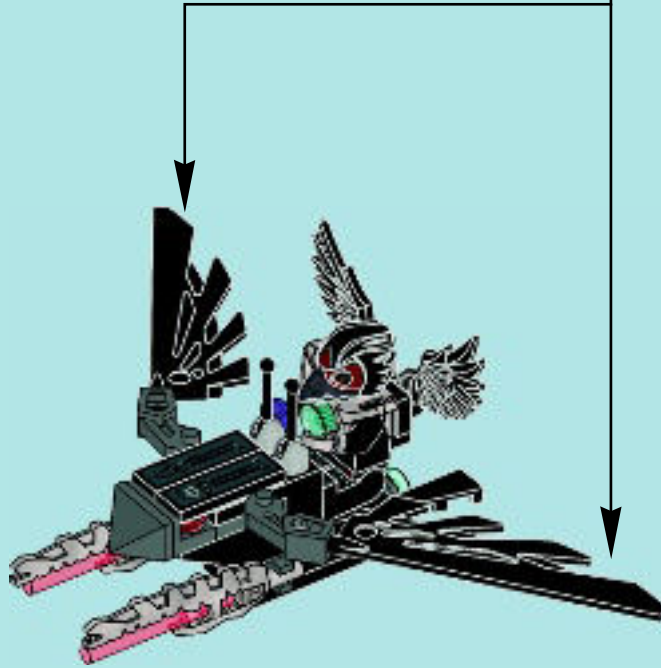

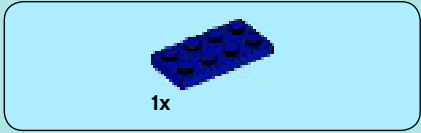

**1**

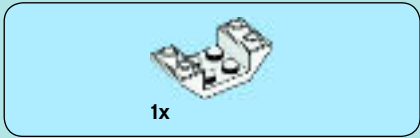
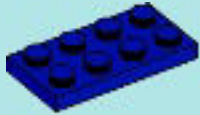

**2**



**3**





2x

4

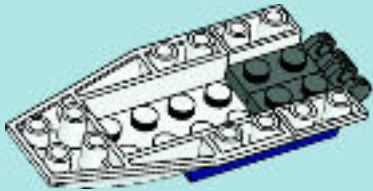

1x



1x

5



2x

6

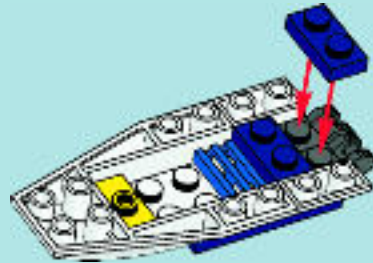



1x

# 7



2x



2x

# 8

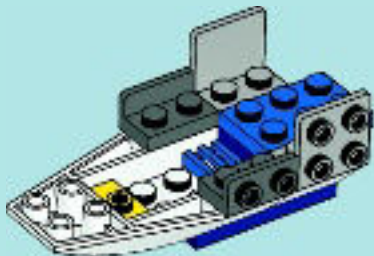

1x



1x



1x

# 9

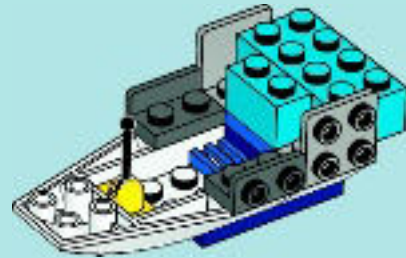





1x



1x

# 10

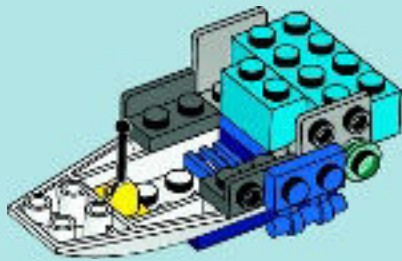

1x



1x

# 11

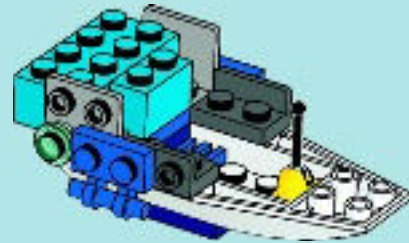
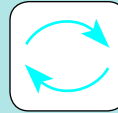

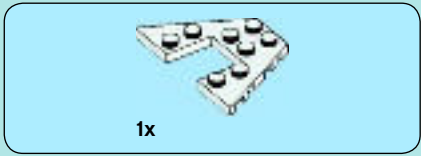

# 12

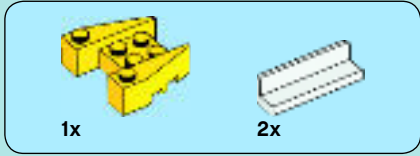
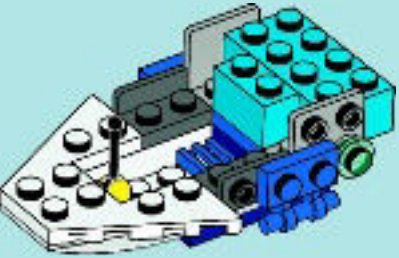

# 13

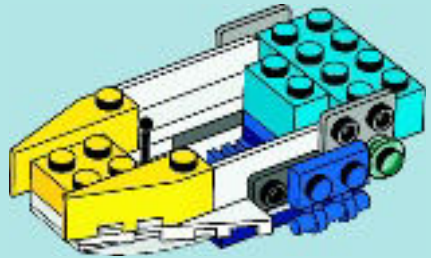

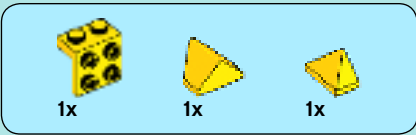

# 14

- 1
- 2
- 3

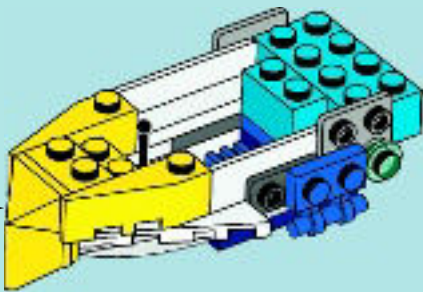



# 15

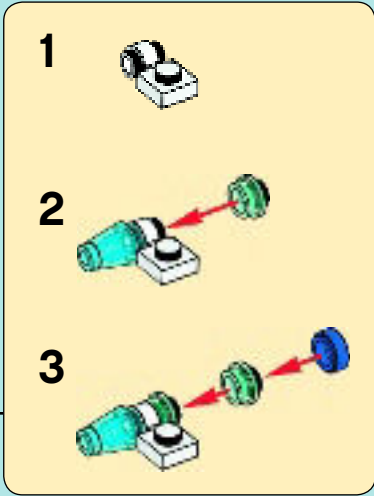
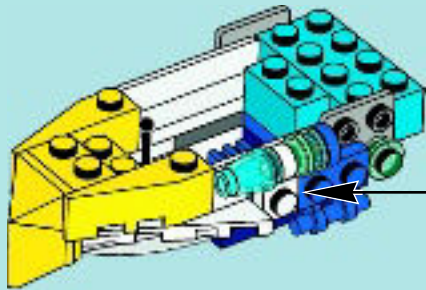

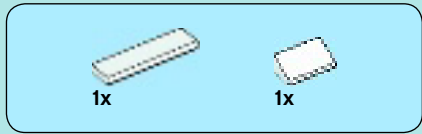

16

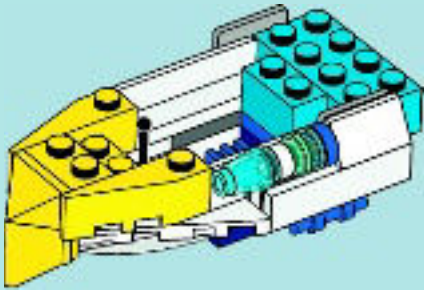

17

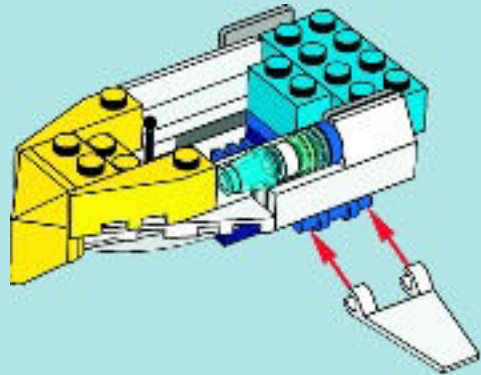



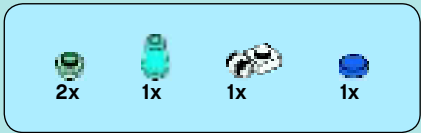

# 18

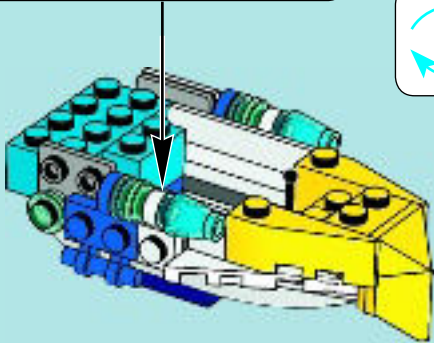
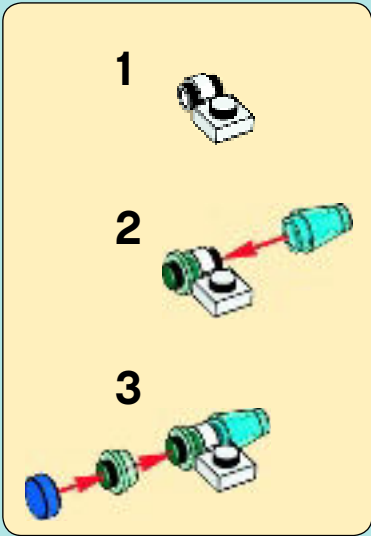

# 19

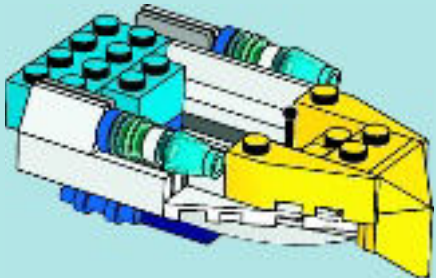



# 20

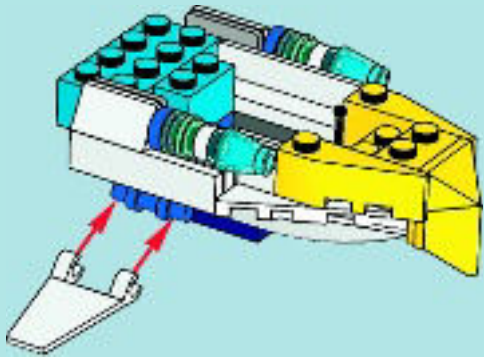

# 21

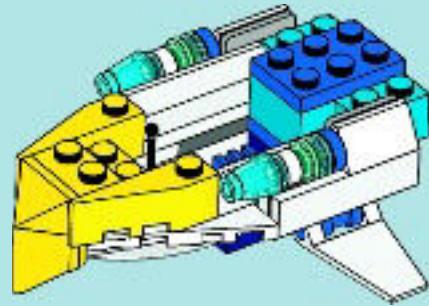
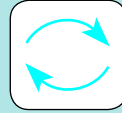



# 22

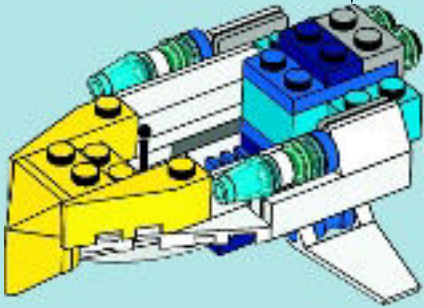
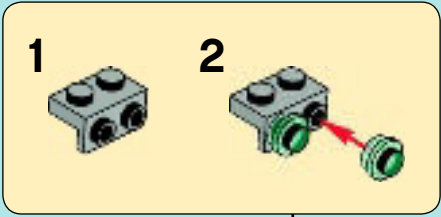

# 23

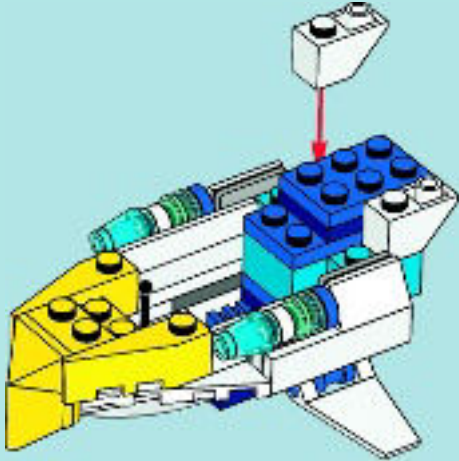



4x

# 24

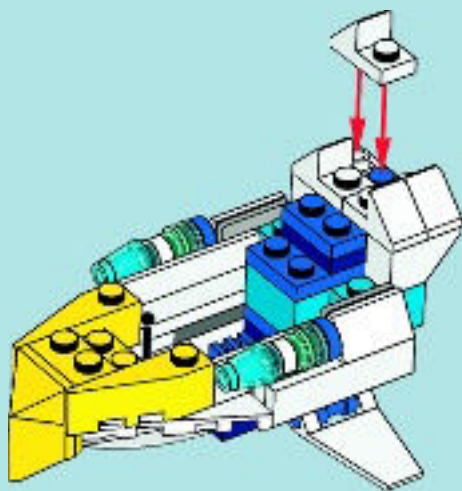

2x

# 25

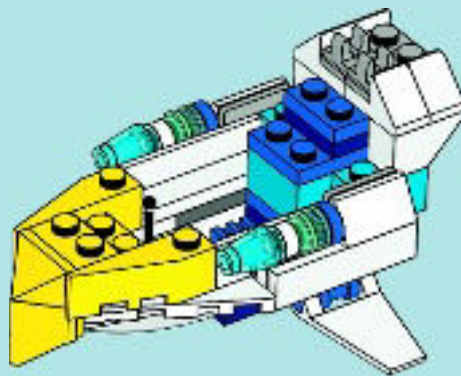

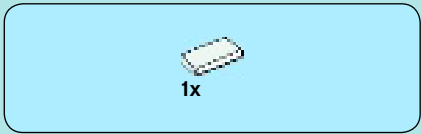

26

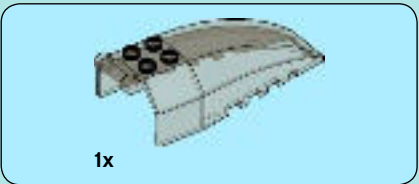
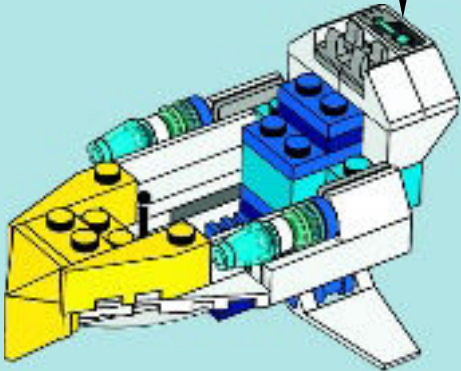
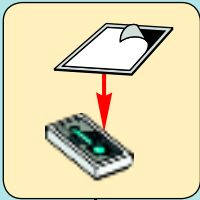

27

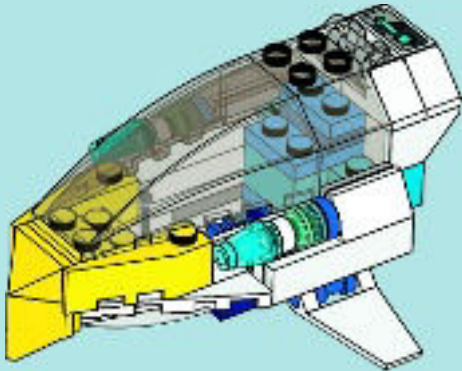



28

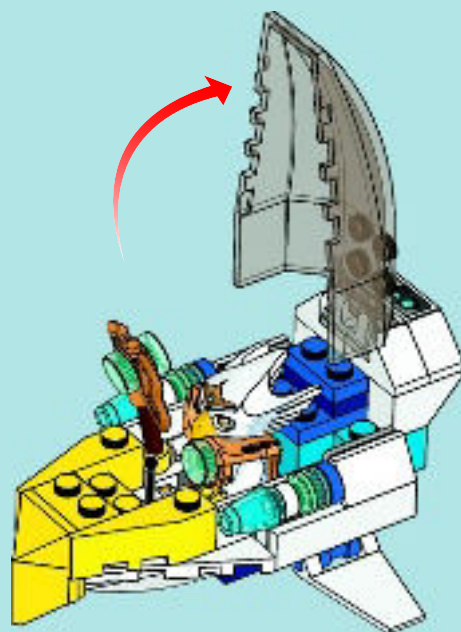

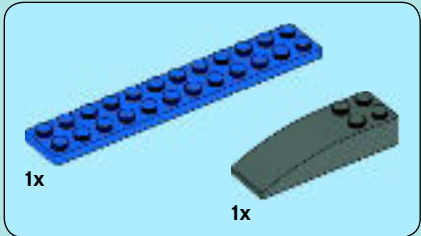
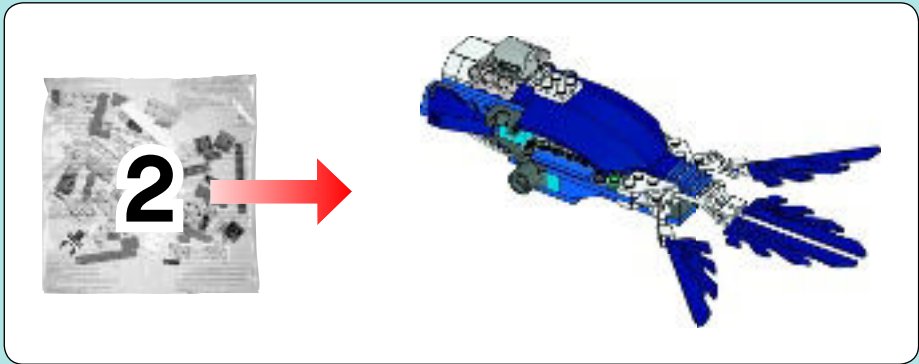

1

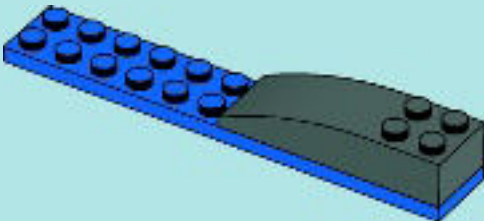

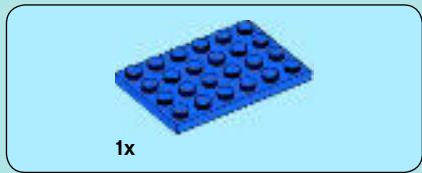

2

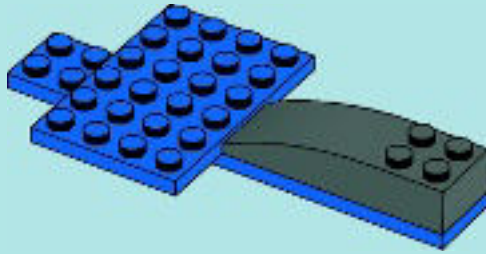

3

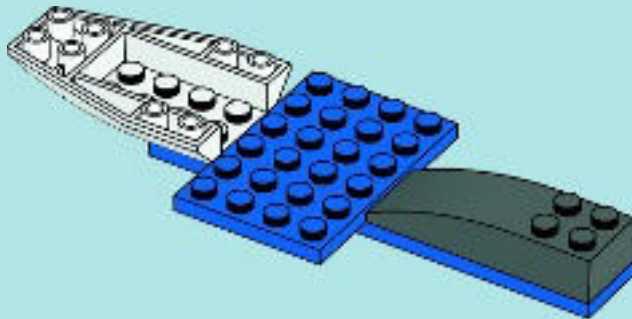

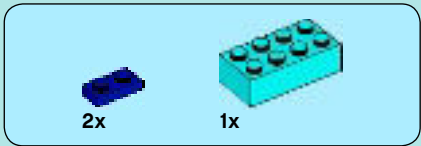

4

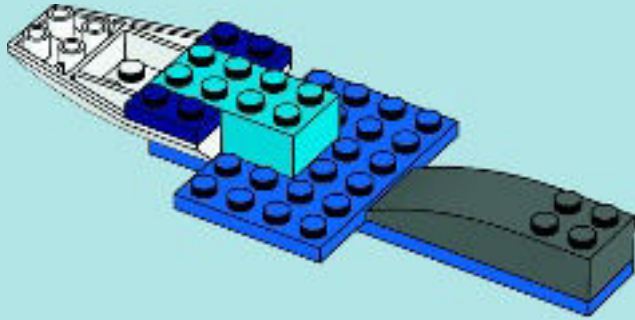

5

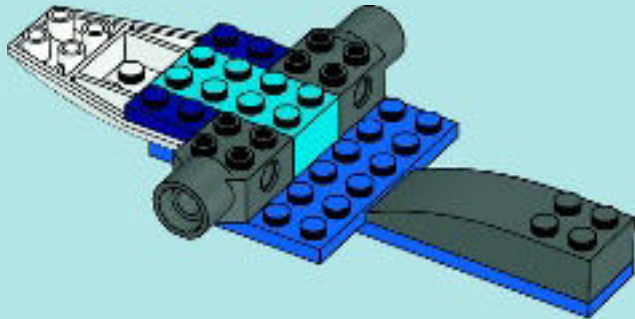



2x



2x

# 6

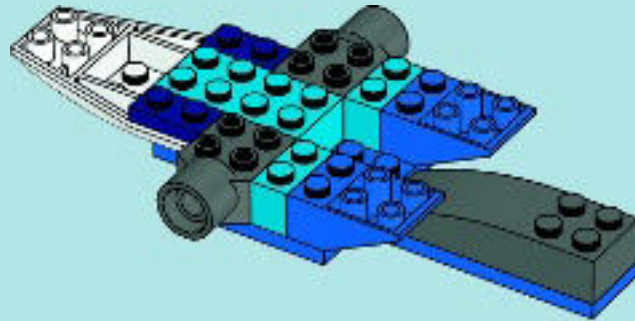

2x

# 7

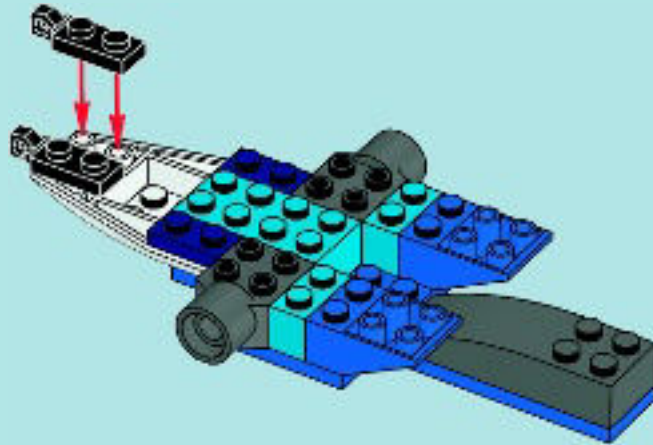

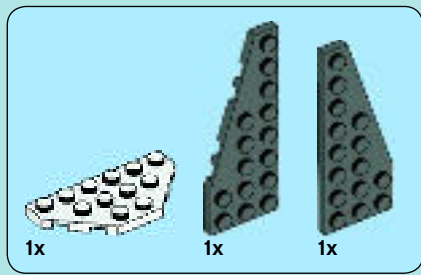

8

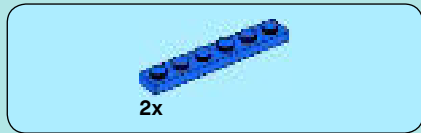
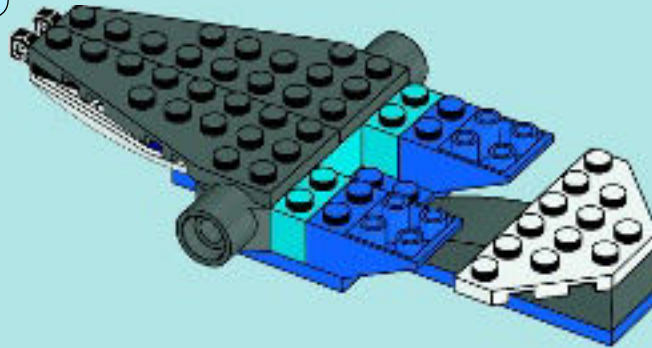

9

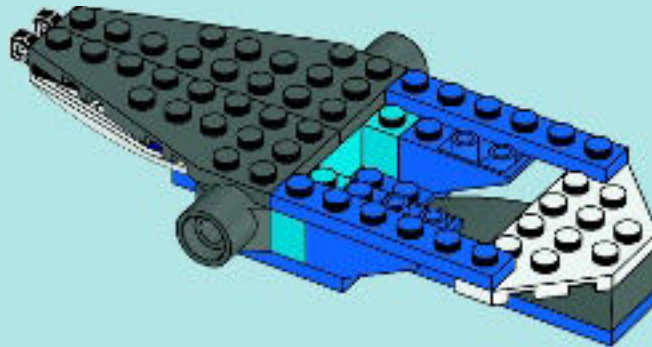



4x

# 10

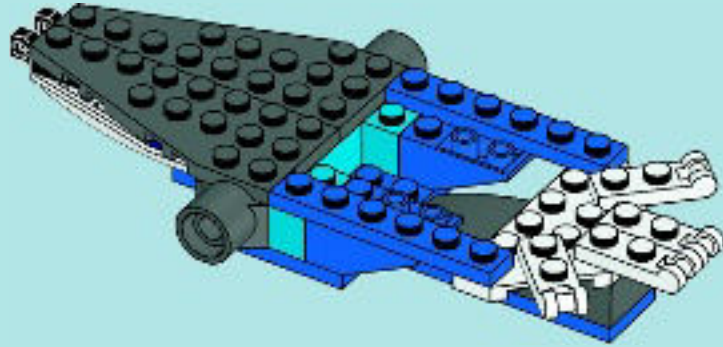

1x

# 11

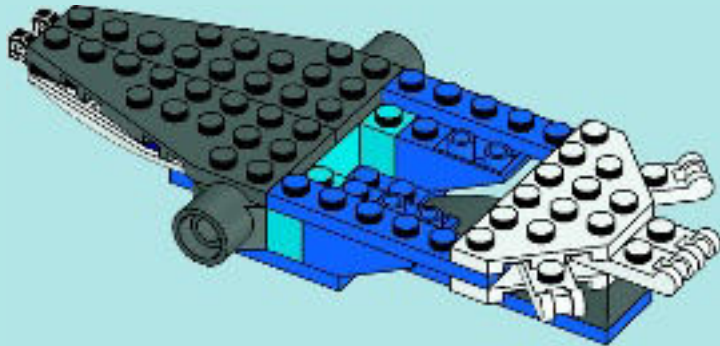



2x



1x

# 12

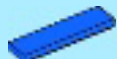
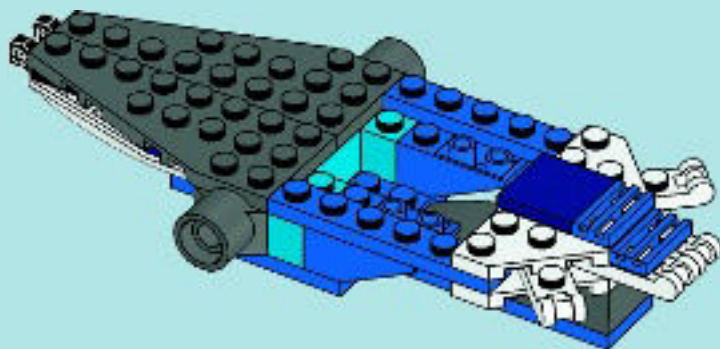

2x



2x

# 13

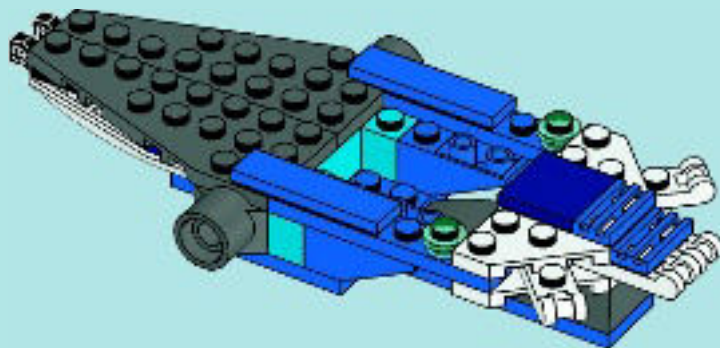





2x

# 14

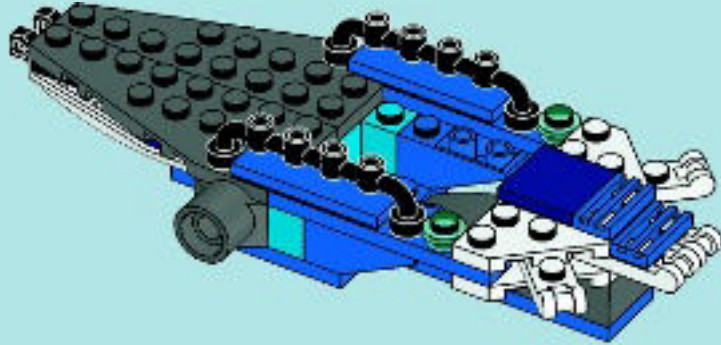

2x



2x



1x

# 15

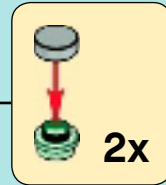

2x

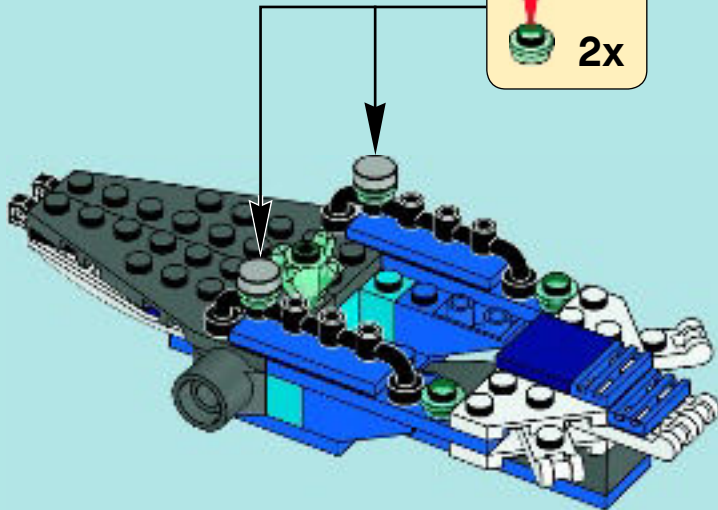

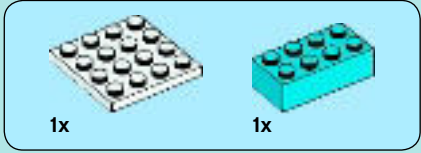

16

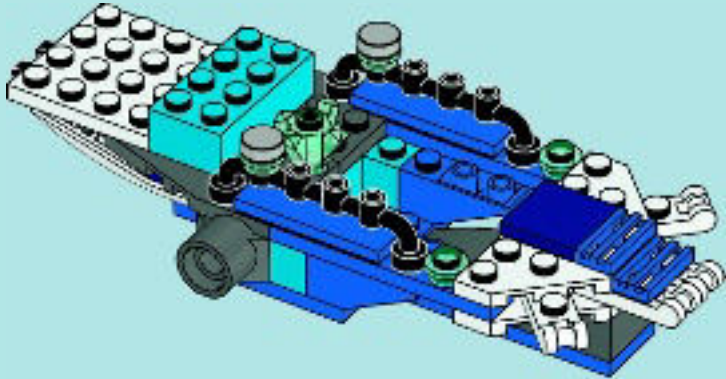



4x

17

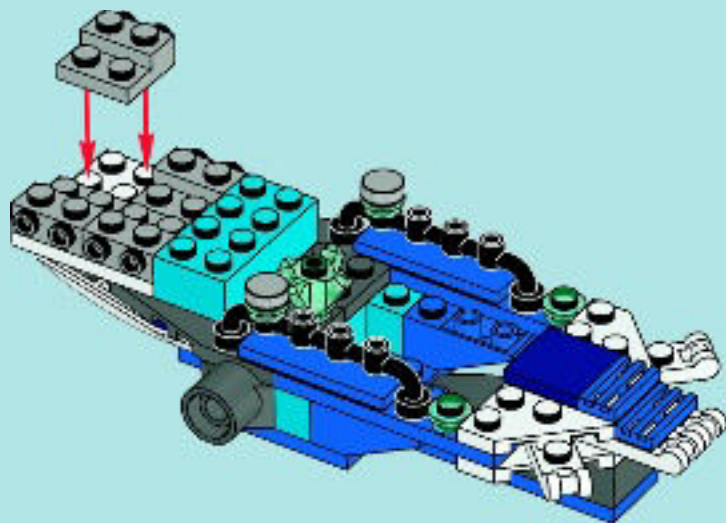



1x



2x

# 18

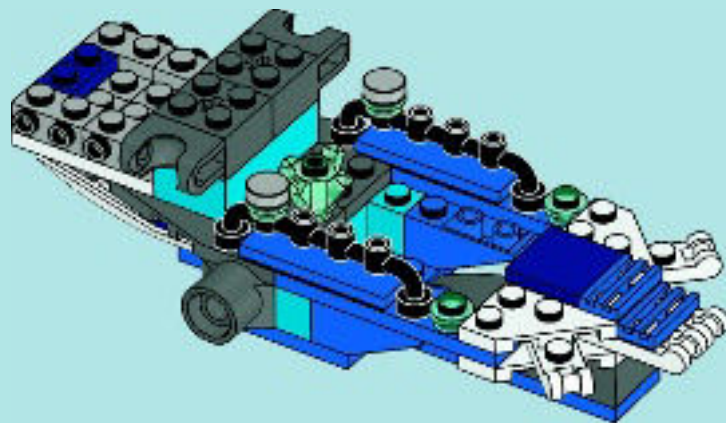



2x



2x

# 19

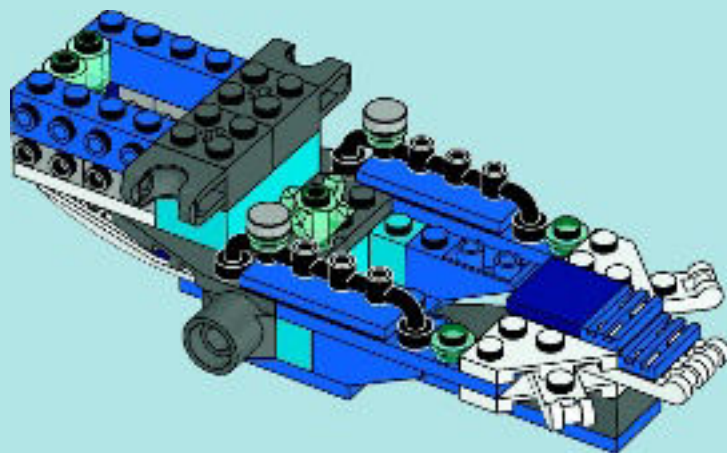

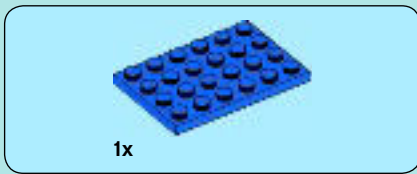

20

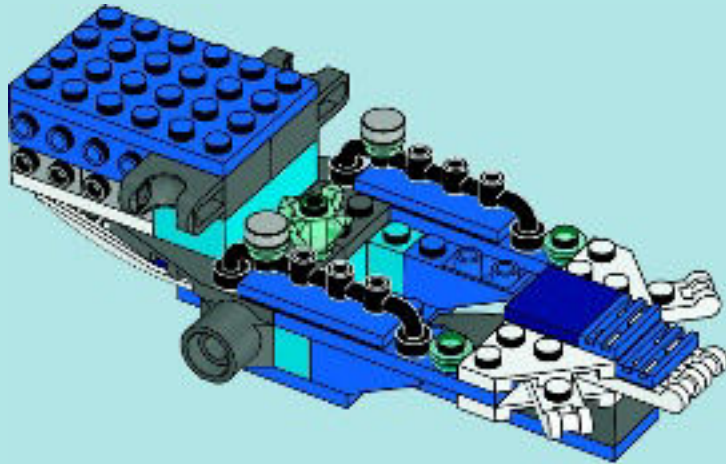

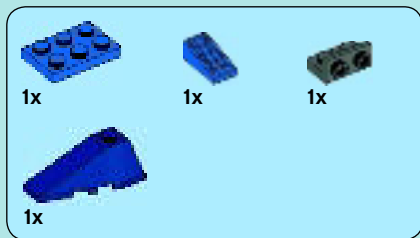

# 21

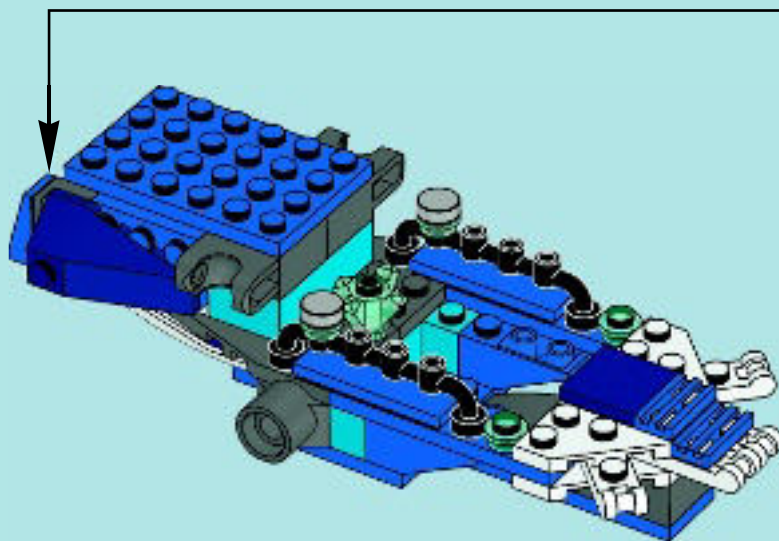
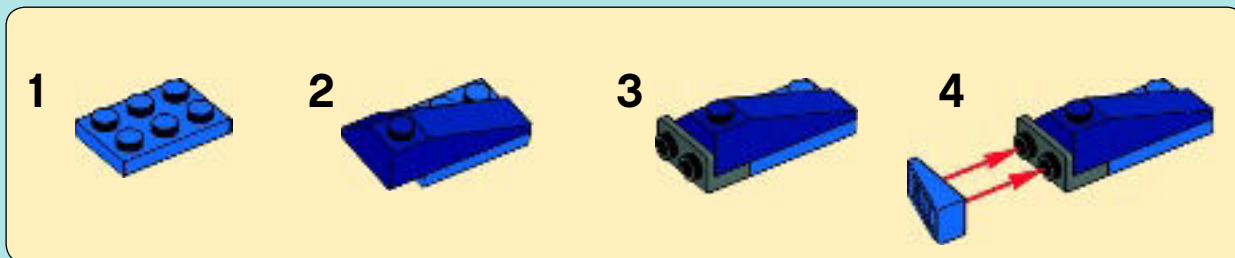

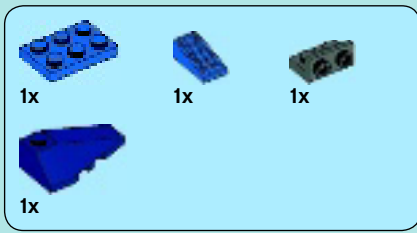

# 22

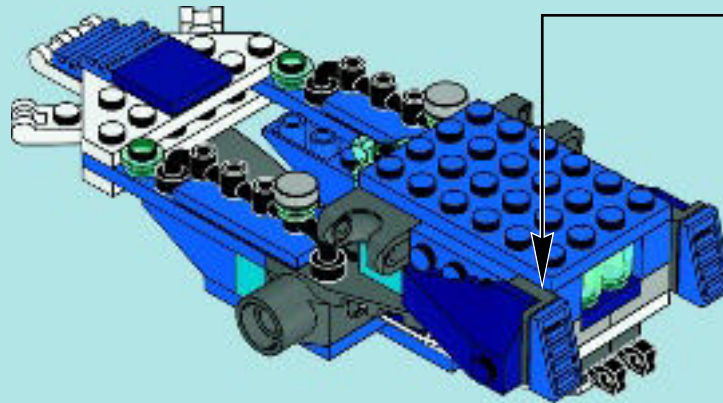
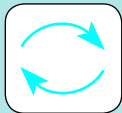
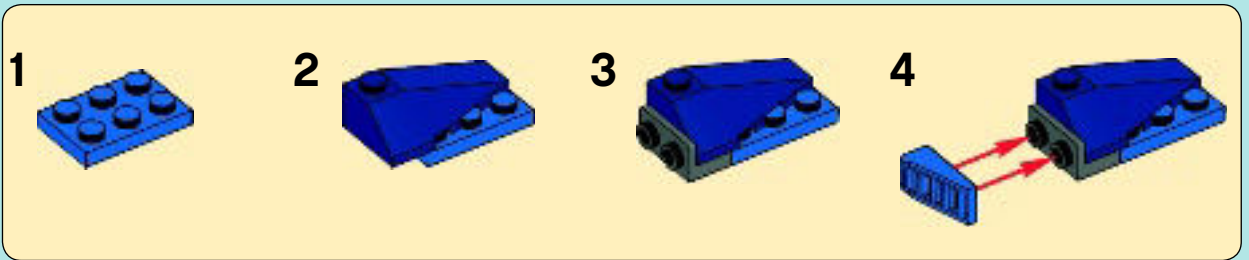





2x



2x

# 23

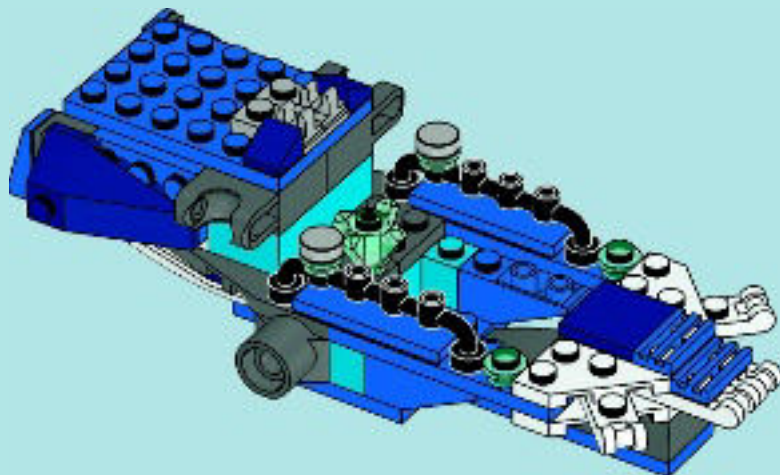
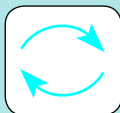



# LEGO CHIMA

**WATCH THE VIDEO  
REGARDE LA VIDEO  
MIRA EL VIDEO**

**SCAN THE QR CODE  
SCANNEZ LE CODE QR  
CAPTURA EL CÓDIGO QR**



**LEGO.COM/CHIMA**





LEGENDS OF  
**CHIMA**

**LAVAL**



70005 70115

**LONGTOOTH**



70005 70113

**LENNOX**



70002 70006  
70104 70011

**LEONIDAS**



70001 70006  
70102

**EWALD**



70011

**ERIS**



70003

**EQUILA**



70004 70013  
70101

**EGLOR**



70013 70105

**EWAR**



70012



700





**ROMINUS**



7006 70103

**CROOER**



70006 70115

**CROOLER**

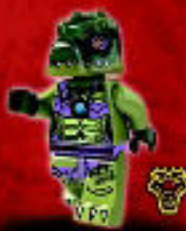

70006

**CRUG**



70002

**CRAWLEY**



70001 70005

**RAWZOM**



70006

**RAZAR**



70003 70012  
70100

**RIZZO**



70003 70012

**RAZCAL**



70000

**WORRIZ**



70011

**WAKZ**



70004 70113

**WILHURT**



70013

**WINZAR**



70004 70106







LEGENDS OF  
**CHIMA**

WATCH THE MODEL  
IN ACTION  
REGARDEZ LE MODÈLE  
EN ACTION  
MIRA EL MODELO  
EN ACCIÓN

SCAN THE QR CODE  
SCANNEZ LE CODE QR  
CAPTURA EL CÓDIGO QR





4x

# 24

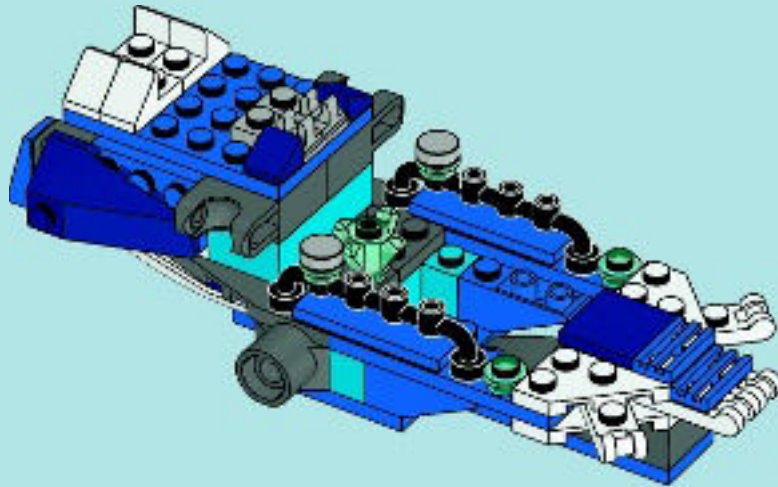



3x



1x

# 25

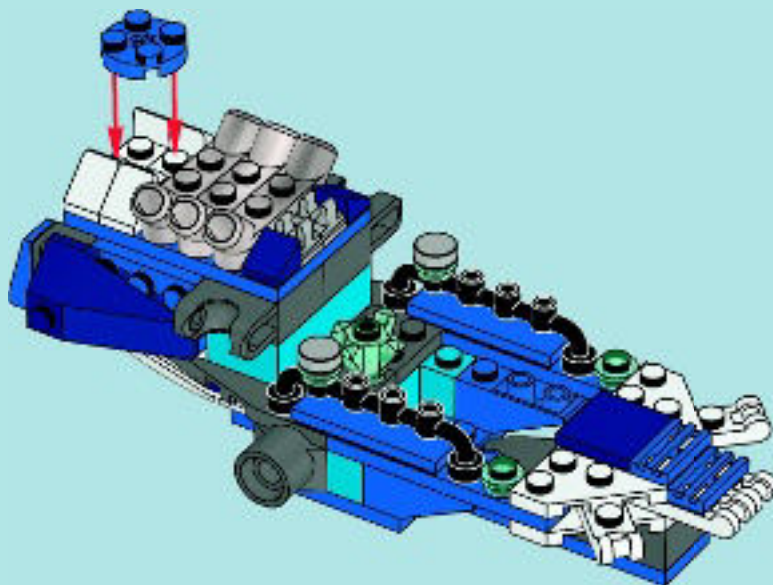



1x



1x

# 26

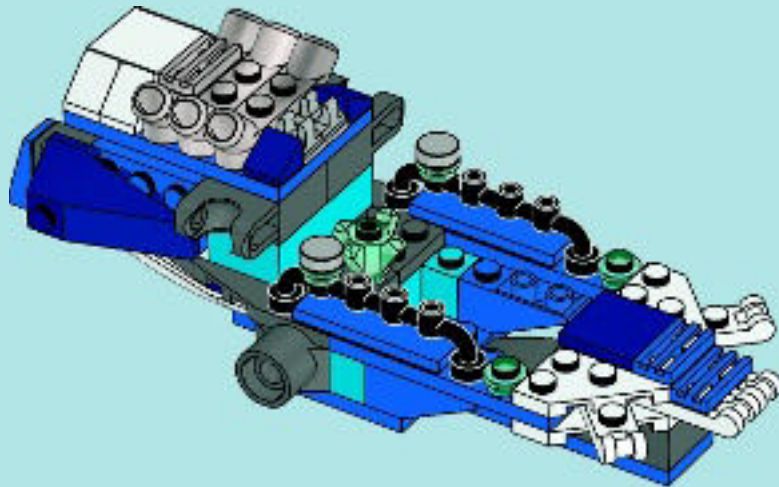





1x

27

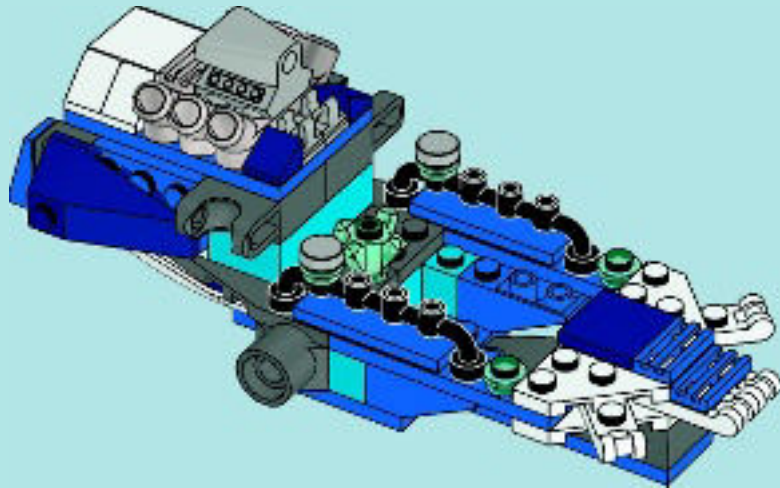



# 28

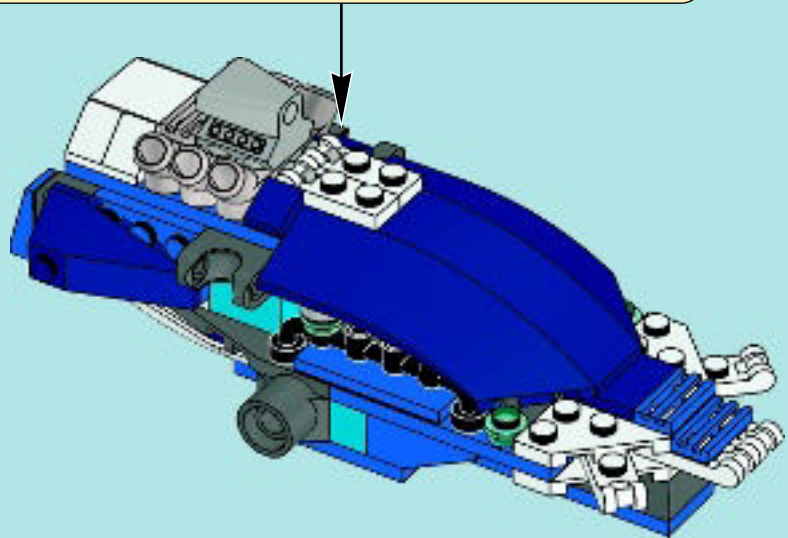
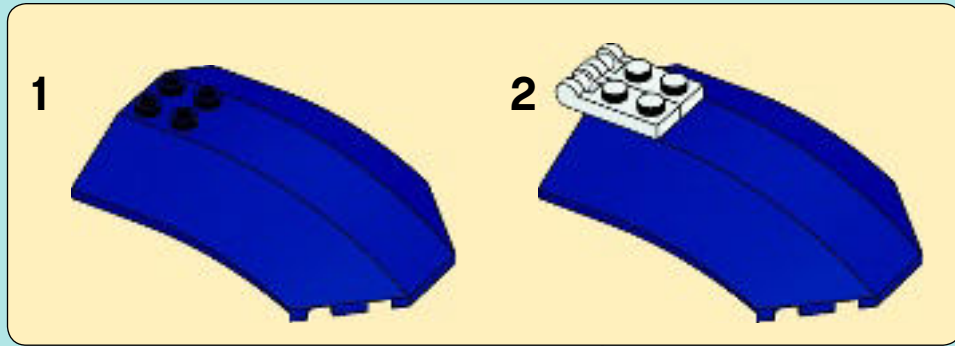



4x

# 29

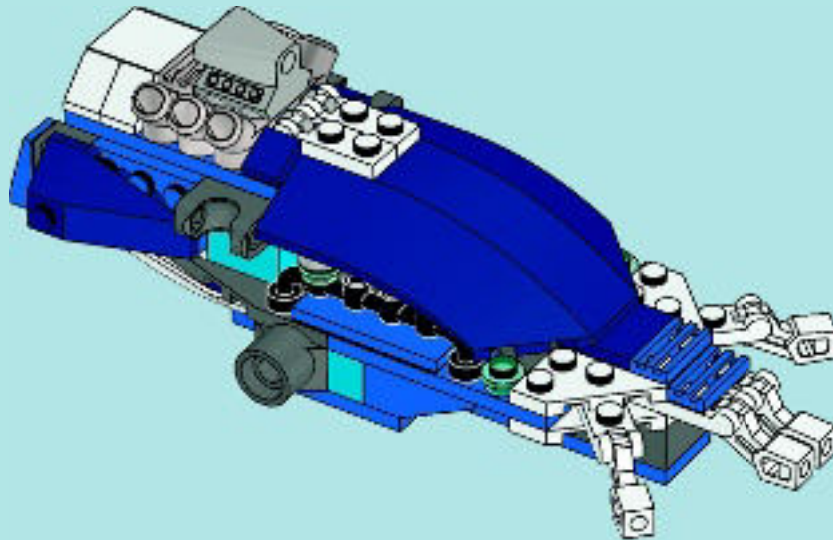

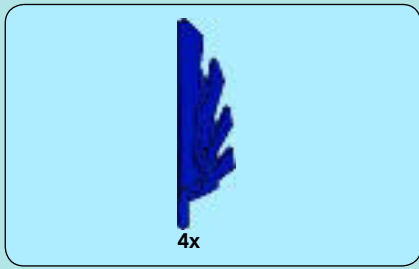

30

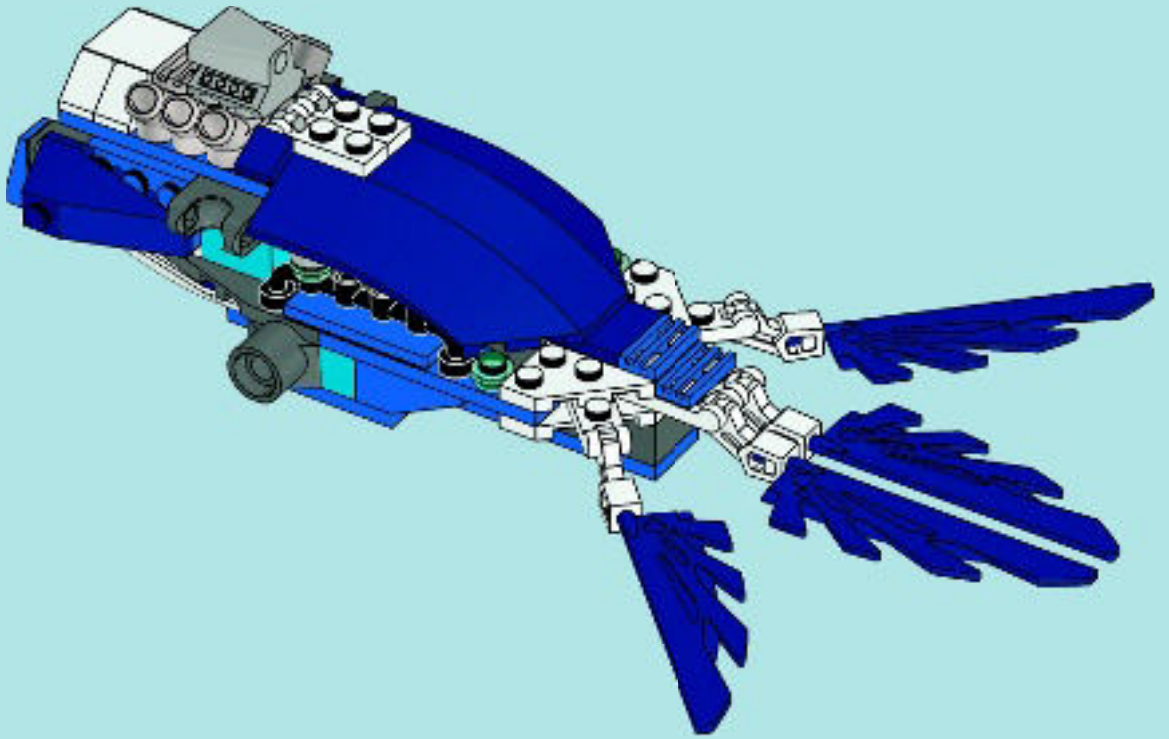



3



2x



1x

1



1x

2





1x

**3**



1x

**4**



2x



1x

**5**

**1**



**2**





1x



1x

6



2x

7



2x

8

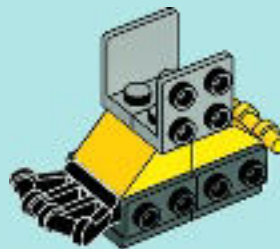



# 9

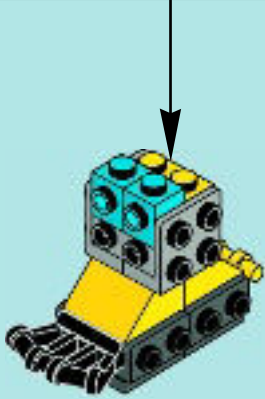
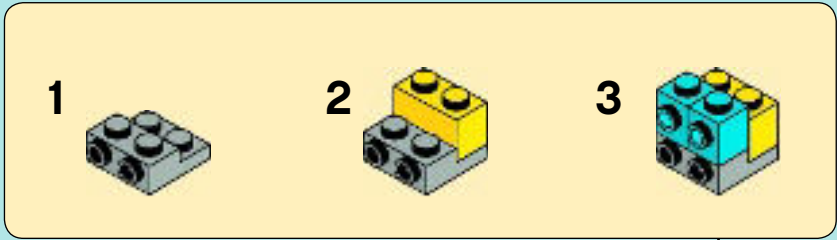





2x

# 10



1x



1x

# 11

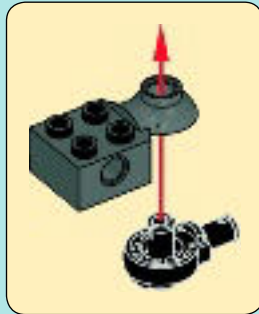
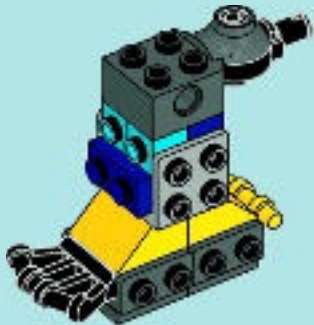

2x

# 12

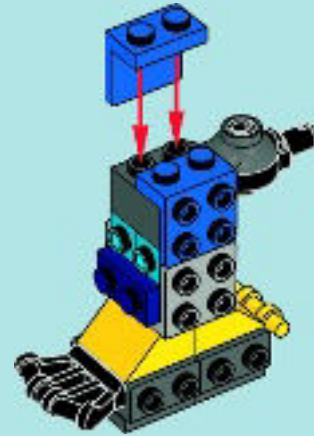

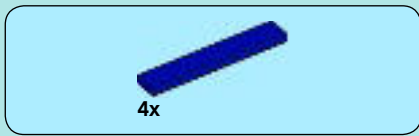

13

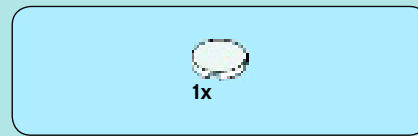
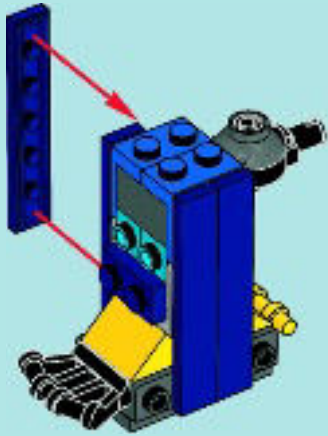

14

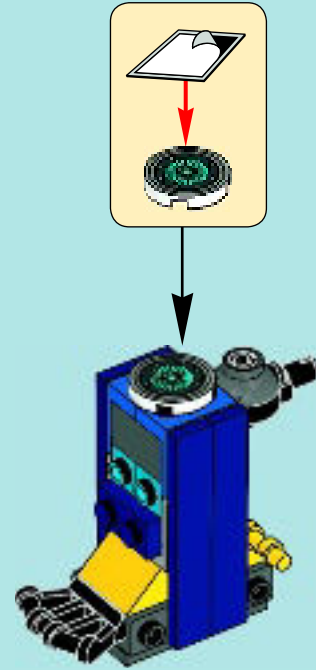



1x

# 15



2x



2x

# 16

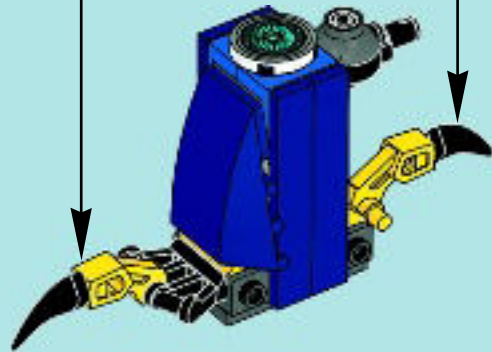



2x



2x

17



2x

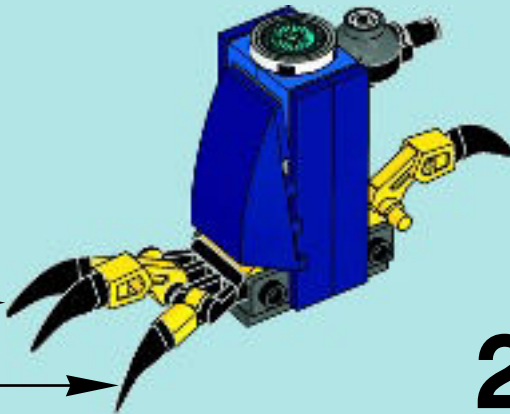

2x

18

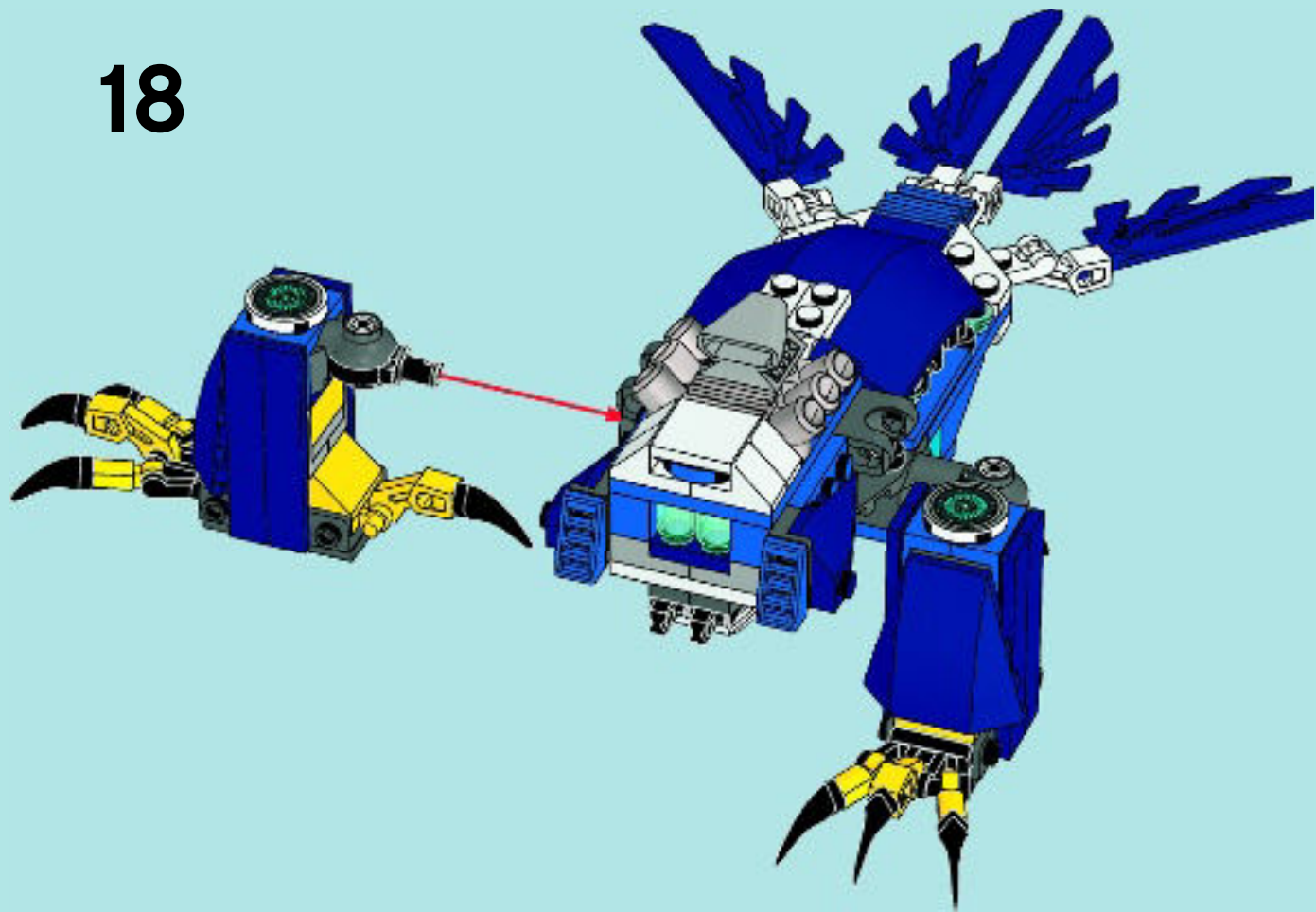

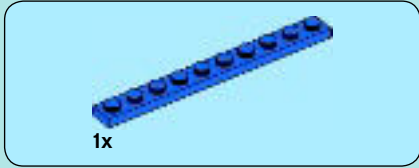

1x

1

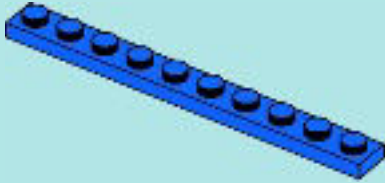

4x

2

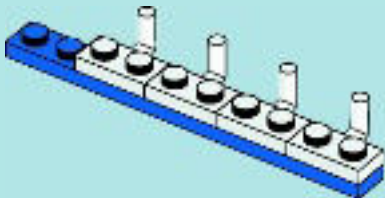

1x

3

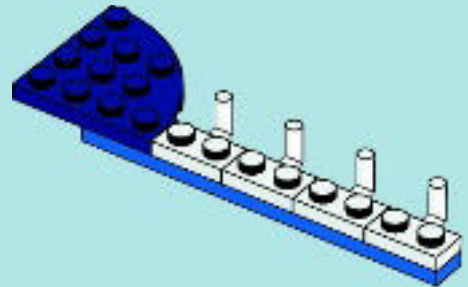



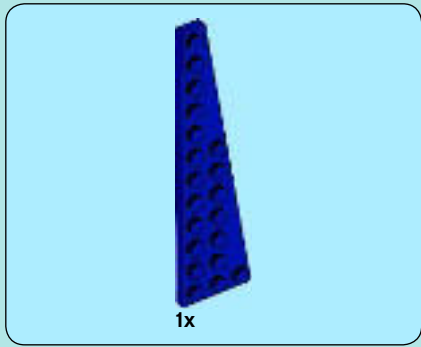

4

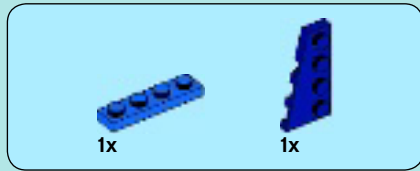
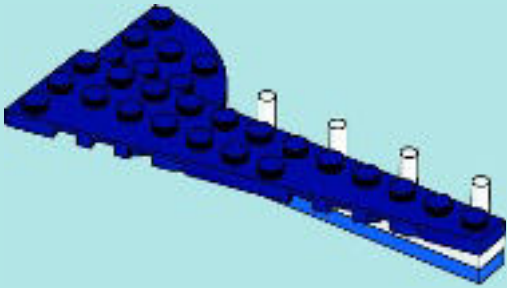

5

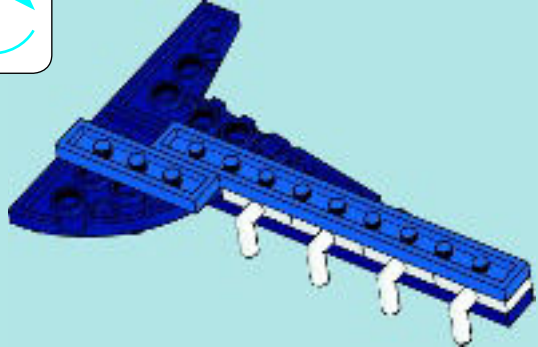
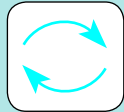
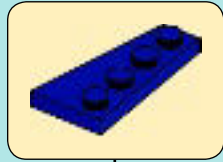



6

1

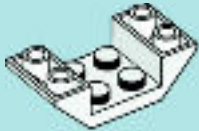

2



3



4

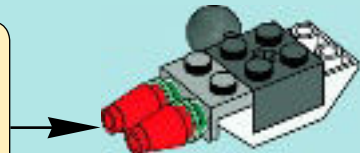
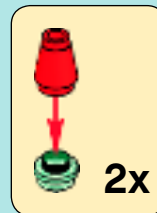

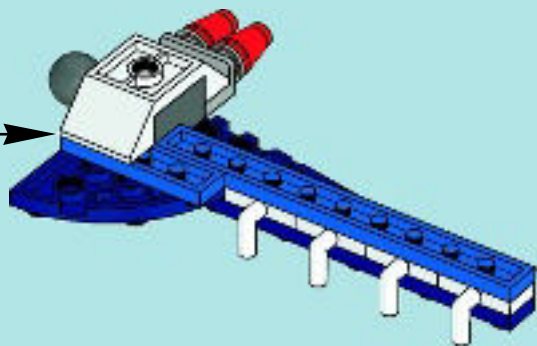
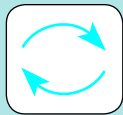

7

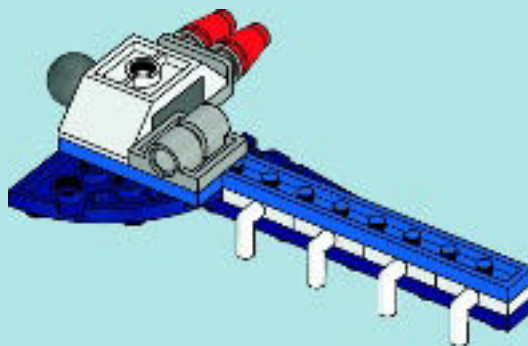



1x



1x

8

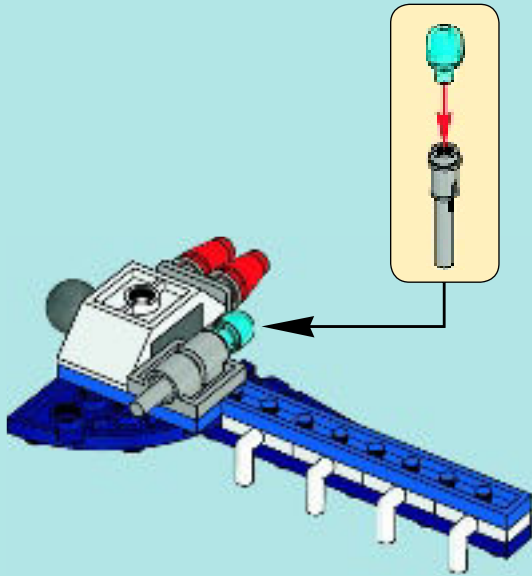

1x



4x

9

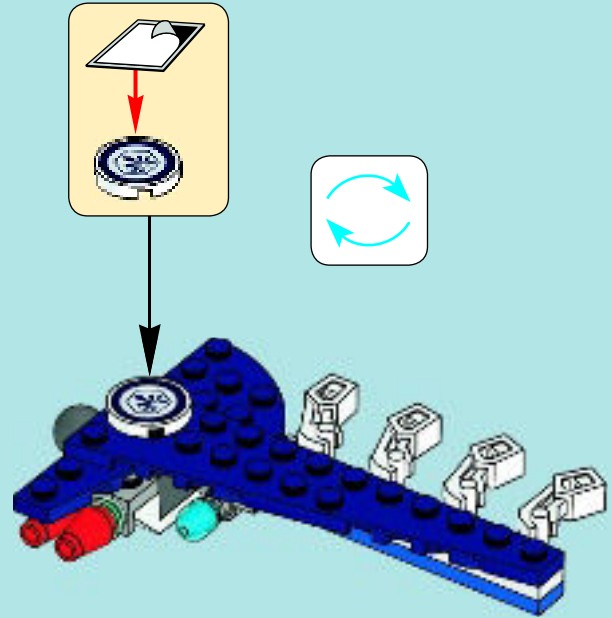

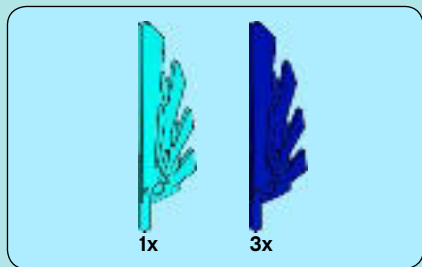

10

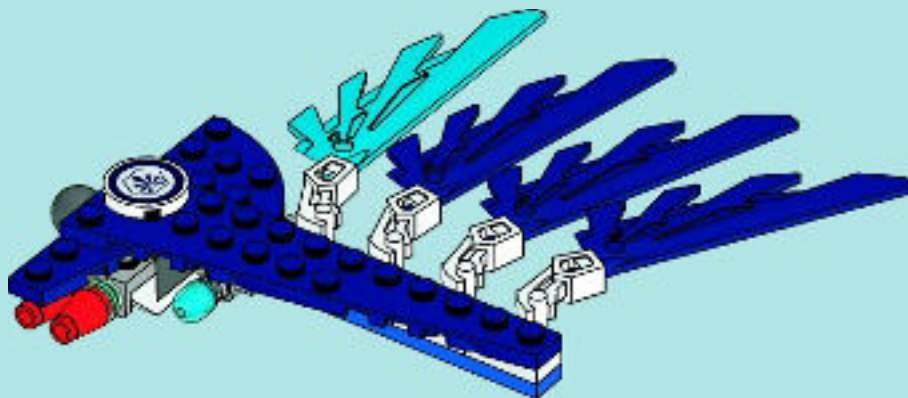

11

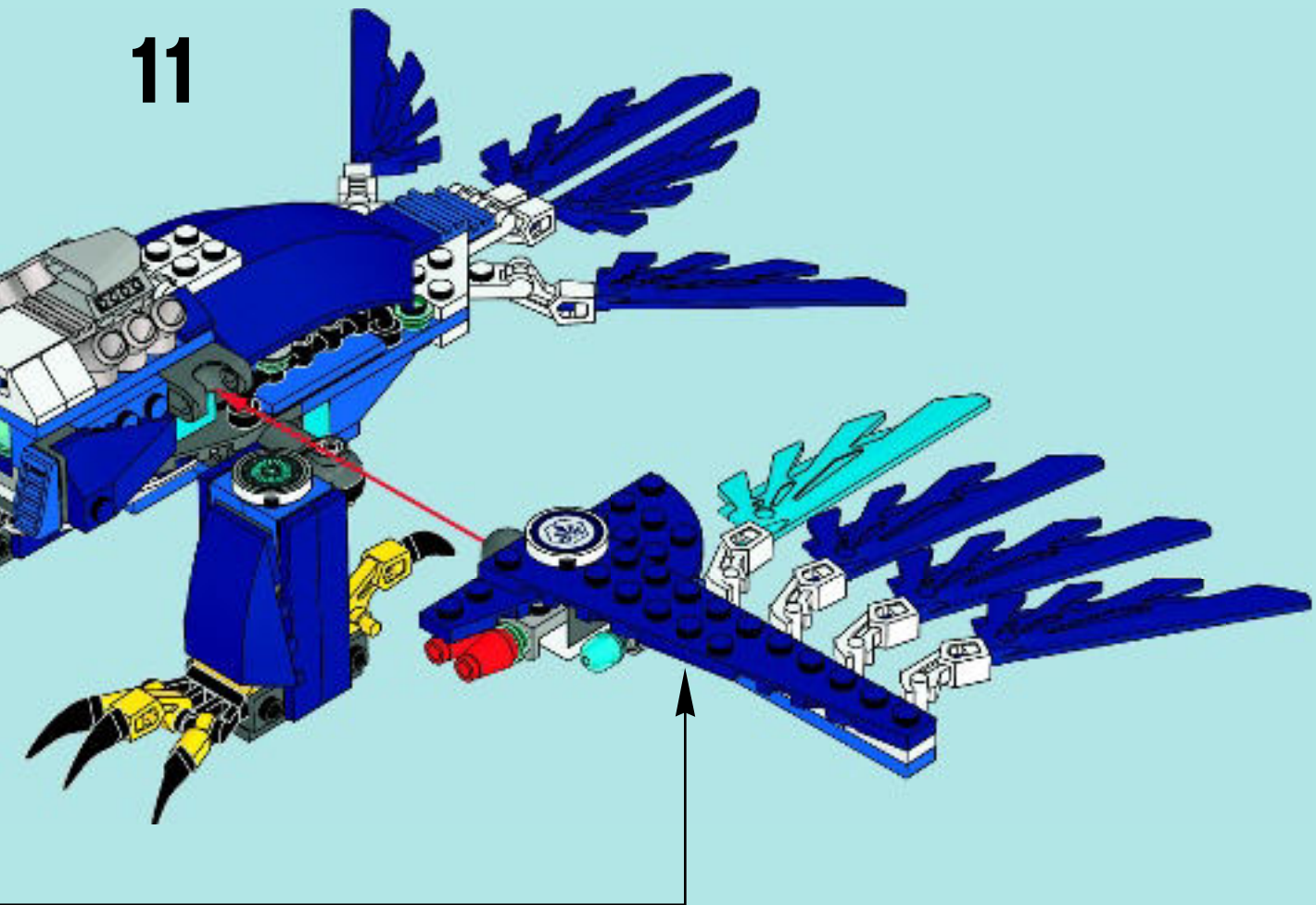



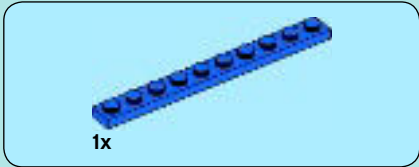

1x

1

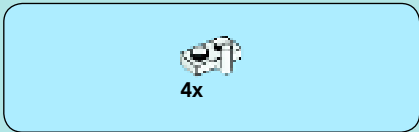
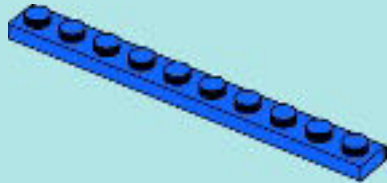

4x

2

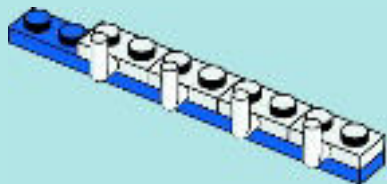

1x

3

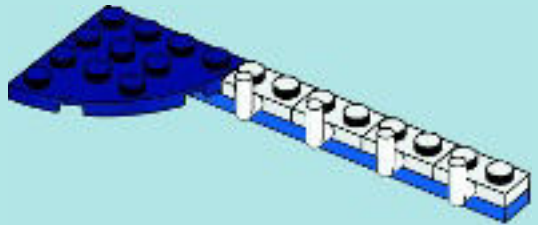

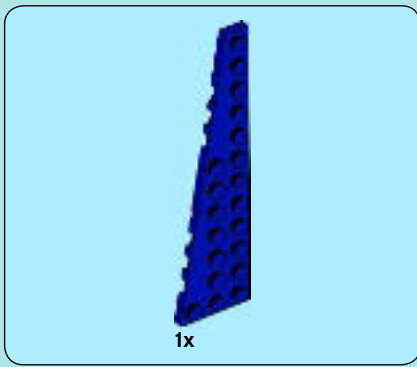

4

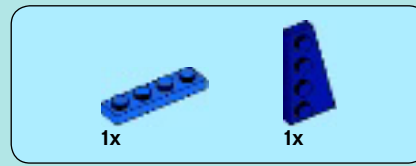
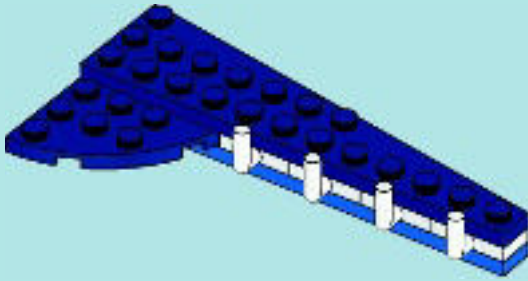

5

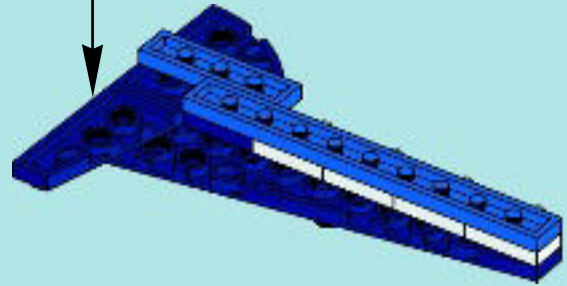
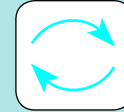



6

1

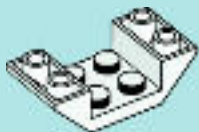

2



3



4

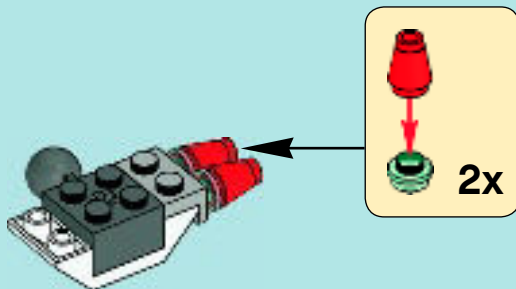



1x

7

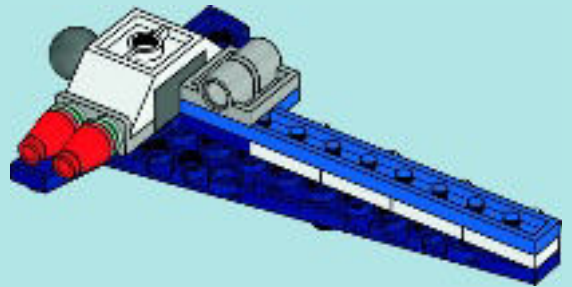
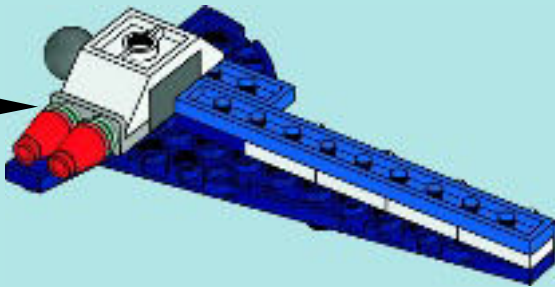

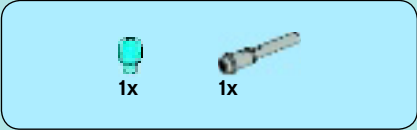

8

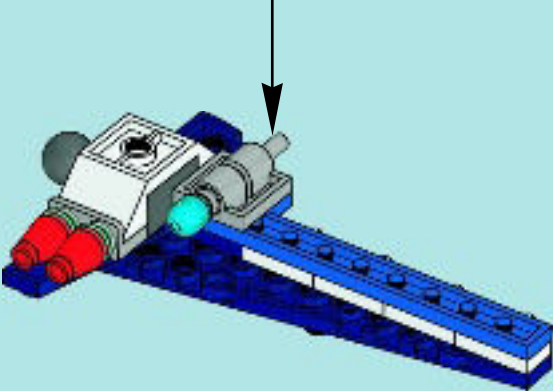
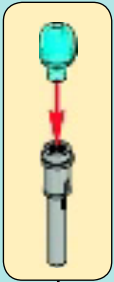

9

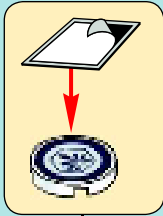
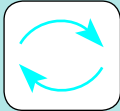

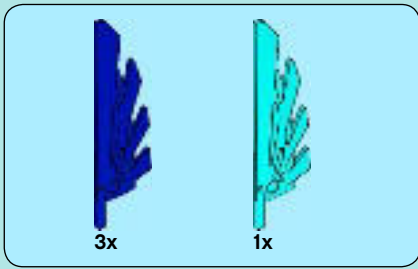

10

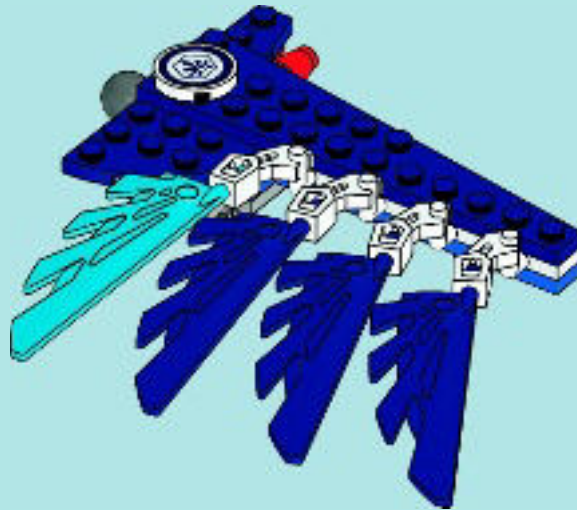





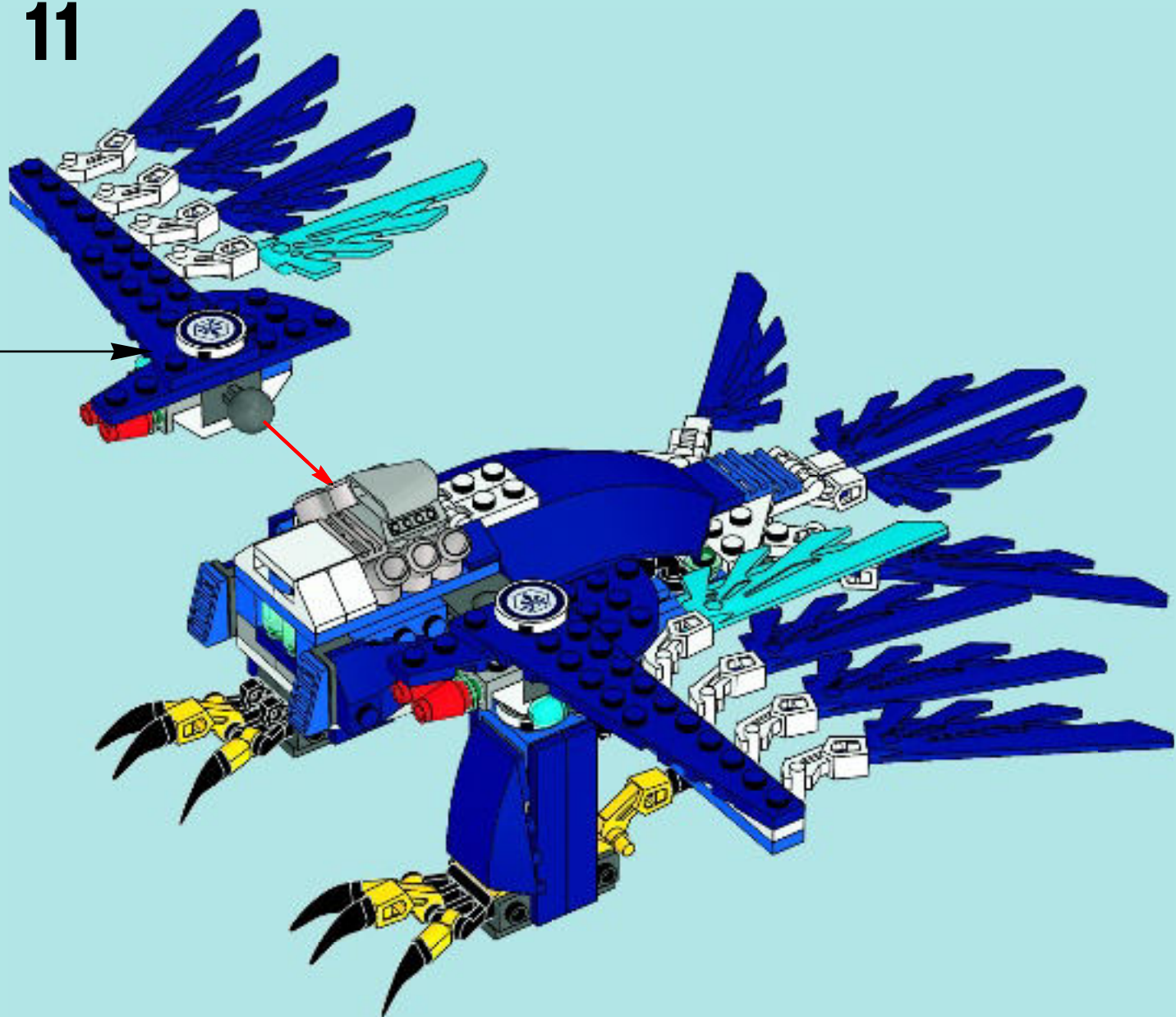

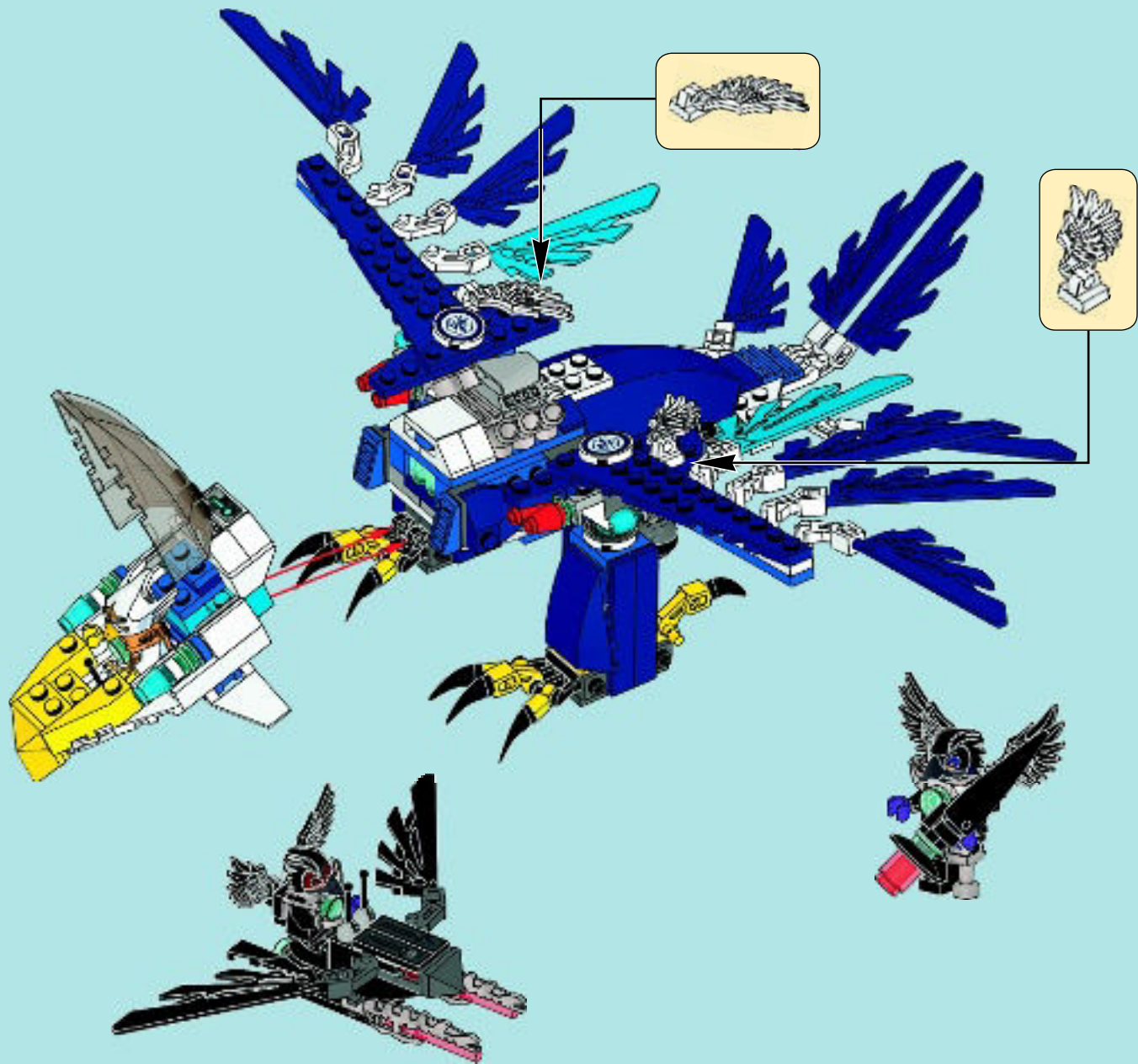

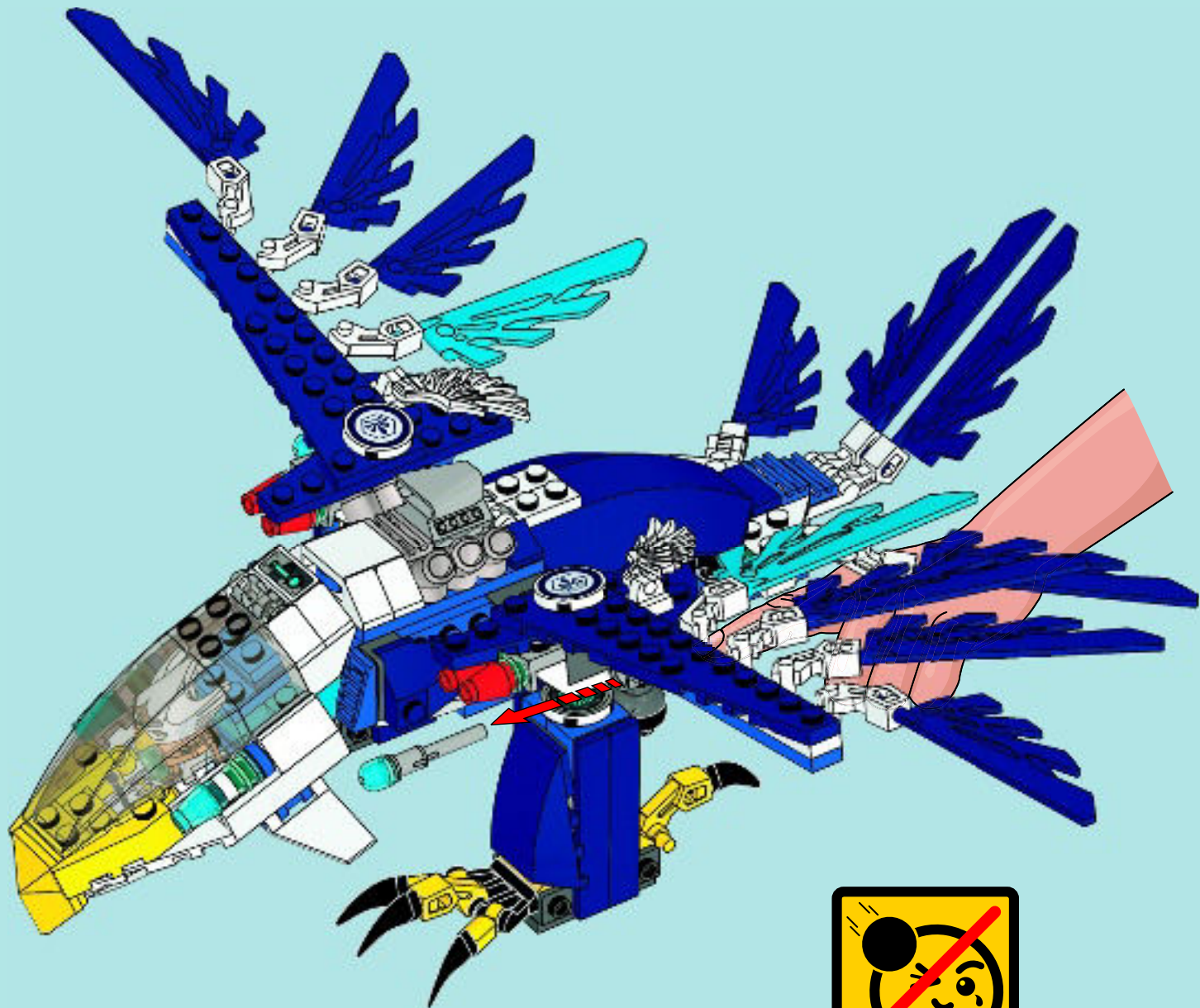

















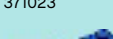





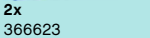













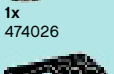





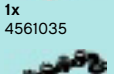





















11









 2x 4547489	 2x 243101	 5x 302123	 4x 6014111	 1x 302026	 1x 6022292
 2x 6023099	 2x 241901	 2x 371023	 2x 300424	 4x 6030718	 1x 4248831
 8x 6015912	 1x 6003065	 2x 366623	 1x 4264028	 2x 4183043	 8x 4563477
 2x 366501	 2x 4173477	 2x 303223	 1x 6023105	 2x 4558170	 1x 6015884
 3x 4173943	 1x 6023872	 2x 447723	 1x 6015239	 1x 474026	 2x 6015899
 2x 4261693	 1x 6022293	 1x 244523	 4x 303924	 1x 4561035	 1x 6022682
 1x 4243812	 12x 6006126	 3x 241223	 1x 379424	 2x 614026	 1x 6018304
 4x 6030716	 2x 6018302	 2x 4140586	 2x 4140587	 1x 6024850	 4x 4213374
 4x 415001	 4x 4529234	 4x 6037412	 1x 74156	 1x 6022564	 1x 3006841
 2x 4632566	 2x 4597338	 2x 243123	 4x 6015892	 1x 6022506	 2x 3005741
 1x 306901	 2x 4212411	 2x 243123	 1x 6012983	 1x 6022509	 3x 4124108
 8x 4611700	 2x 4509443	 1x 403223	 1x 374726	 1x 6022289	 2x 4183544
 1x 306801		 2x 4009460			
 6x 4515364					



1x  
6019570



5x  
6022171



15x  
4163917



1x  
4598530



2x  
4537937



1x  
6018407



2x  
4504374



1x  
6020833



1x  
6020832



2x  
4226924



10x  
4528981



1x  
4667595



1x  
4205004



8x  
4252437



1x  
4529954



1x  
4502091



2x  
6023154



1x  
4647621



1x  
4647622



10x  
6015895



2x  
4567331



2x  
4497952



2x  
4650260



4x  
4598526



3x  
4654582



6x  
4654580



2x  
4221775



2x  
4211376



2x  
4520320



1x  
4259422



6x  
4654577



2x  
4225973



2x  
4497253



2x  
4227395



2x  
4619760



2x  
4539097



1x  
4262974



1x  
4552203



1x  
4210873



2x  
4579354



2x  
4611703



14x  
6000606



4x  
6025210



2x  
4210884



2x  
6012812



1x  
4529728



1x  
4529727



1x  
6022550



1x  
6022500



1x  
6020600



1x  
6019984



1x  
4619636



3x  
6024040



2x  
6029660



3x  
4632100



3x  
6004943



3x  
4655172



4x  
6004938



2x  
6015896



**Customer Service**  
Kundenservice  
Service Consommateurs  
Servicio Al Consumidor  
[LEGO.com/service](http://LEGO.com/service) or dial



00800 5346 5555 :



1-800-422-5346 :





# REMAINS OF CHIMA



LENNOX CRAEGER



70006



70000



70001



70006



70005



70004



70003



70002





# LEGO CHIMA

# SPEEDORZ



70115



70115



WATCH THE MODEL IN ACTION  
REGARDEZ LE MODÈLE EN ACTION  
MIRA EL MODELO EN ACCIÓN



70100

70103

70102

70113







# LEGENDS OF CHIMA



**LEGO.COM/CHIMA**



**LEGO** CHIMA 4D



**EN EXCLUSIVITÉ  
À LEGOLAND.  
- L'EXPÉRIENCE  
CHIMA EN 4D**  
OBTENEZ PLUS D'INFORMATIONS ET DES  
OFFRES SPÉCIALES SUR  
[LEGOLAND-CHIMA.COM](http://LEGOLAND-CHIMA.COM)



**EXCLUSIVELY  
AT LEGOLAND.  
- THE 4D CHIMA  
EXPERIENCE**  
FIND OUT MORE AND GET SPECIAL OFFERS AT  
[LEGOLAND-CHIMA.COM](http://LEGOLAND-CHIMA.COM)



**SÓLO EN LEGOLAND.  
LA EXPERIENCIA  
CHIMA 4D**  
MAS INFORMACION Y OFERTAS ESPECIALES EN  
[LEGOLAND-CHIMA.COM](http://LEGOLAND-CHIMA.COM)

  
**LEGOLAND**  
DISCOVERY CENTERS

  
**LEGOLAND**  
PARKS



1



2



3

[www.LEGOclub.com/Max](http://www.LEGOclub.com/Max)

[www.LEGOclub.com/Max](http://www.LEGOclub.com/Max)



**LEGO** club™

**FREE\*! GRATIS! GRATUIT !**

\*Paid subscription in Australia and New Zealand.  
\*Abonnement payant en Australie et Nouvelle-Zélande.

©2013 The LEGO Group.

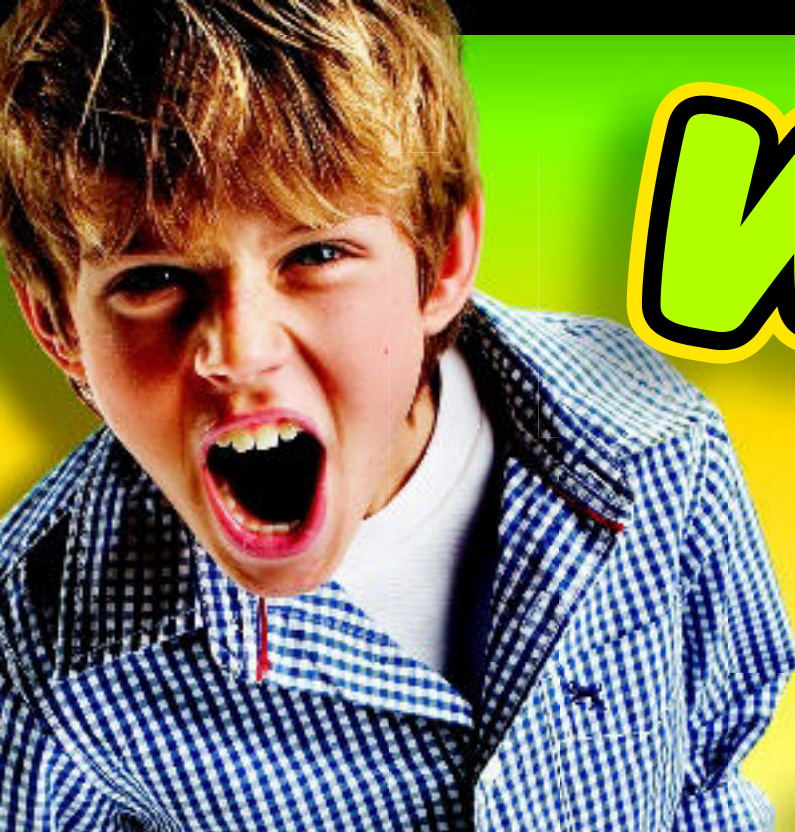

# WIN!

Go to [www.LEGOsurvey.com/product](http://www.LEGOsurvey.com/product)  
to fill out a survey for a chance  
to win a cool LEGO® Product.  
No purchase necessary.  
Open to all residents where not prohibited.



## [www.LEGOsurvey.com/product](http://www.LEGOsurvey.com/product)

### GEWINNE! WIN!

Nimm an der Umfrage auf  
[www.LEGOsurvey.com/product](http://www.LEGOsurvey.com/product)  
teil und hab die Chance ein cooles  
LEGO® Produkt zu gewinnen!

Die Teilnahme am Gewinnspiel führt zu keinerlei  
Kaufverpflichtungen. Teilnahme in allen nicht  
ausgeschlossenen Ländern möglich.

Ga naar [www.LEGOsurvey.com/product](http://www.LEGOsurvey.com/product),  
vul een  
enquêteformulier in en maak  
kans op een cool LEGO® product.

Geen aankoopverplichting.  
Iedereen mag deelnemen, uitgezonderd  
ingezetenden van landen waar een  
enquêteverbod geldt.

### GAGNE! 当てよう!

Visite [www.LEGOsurvey.com/product](http://www.LEGOsurvey.com/product)  
pour répondre à un  
questionnaire et avoir une chance de  
gagner un produit LEGO® très cool!

Aucune obligation d'achat.  
Ouvert à tous les résidents des pays  
autorisés.

[www.LEGOsurvey.com/product](http://www.LEGOsurvey.com/product) にアクセスして、  
アンケートにご記入ください。当選者にはレゴ  
製品を差し上げます。

お買い上げの必要はありません

禁止されていない限り、すべての皆様にご利用いただけます。