

LEGENDS OF
CHIMA
TM

70008

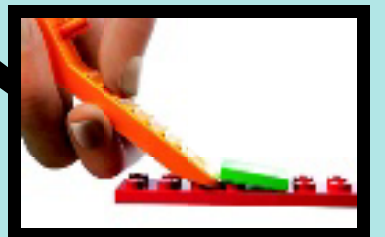

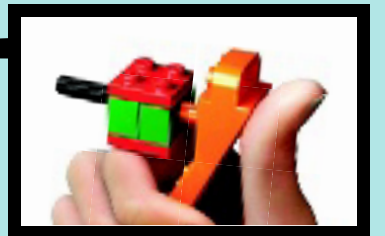
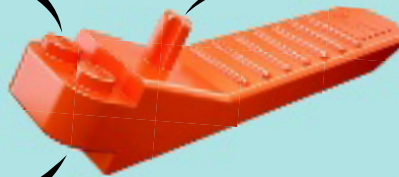

LEGO.com/brickseparator

EN IMPORTANT: Never modify the elements or use other projectiles than provided with this toy.
 DE WICHTIG: Die Elemente dürfen nicht verändert werden. Es dürfen ausschließlich die mit dem Spielzeug mitgelieferten Geschosse verwendet werden.
 FR IMPORTANT : Ne jamais modifier les éléments ni utiliser d'autres projectiles que ceux fournis avec ce jouet.
 IT IMPORTANTE: non modificare gli elementi o utilizzare proiettili non forniti con questo prodotto.
 NL BELANGRIJK! Verander niets aan de elementen en gebruik geen andere projectielen dan de bij het speelgoed geleverde.
 ES IMPORTANTE: No modifique los elementos ni utilice otros proyectiles diferentes a los suministrados junto con este juguete.
 DA VIGTIGT: Elementerne må ikke ændres, og der må ikke bruges andre projektiler end dem, der følger med legetøjet.
 FI TÄRKEÄÄ: Älä koskaan tee osiin muutoksia tai käytä lelussa muita kuin sen sisältämiä ammuksia.
 SV VIKTIGT: Modifiera aldrig delarna och använd aldrig andra projektiler än de som medföljer denna leksak.
 PT IMPORTANTE: Nunca modifique os elementos nem utilize projécteis que não tenham sido fornecidos com este brinquedo.
 EL ΣΗΜΑΝΤΙΚΟ: Ποτέ μην τροποποιείτε τα στοιχεία του παιχνιδιού και μην χρησιμοποιείτε άλλα βλήματα εκτός από αυτά που συνοδεύουν αυτό το παιχνίδι.
 JA 重要： 部品を改造したり、本製品に付属の発射体以外のものを使用しないようにしてください。
 ZH 重要提示： 切勿更改组件或使用并非由本玩具附带的弹丸。
 KO 중요함: 이들 부품을 수정하거나 이 완구와 함께 제공된 것이 아닌 발사체는 결코 사용하지 마십시오.
 RU ВАЖНО: запрещается вносить изменения в элементы или использовать другие снаряды, отличные от тех, которые поставляются с данной игрушкой.
 PL WAŻNE: Nigdy nie modyfikować elementów zabawki ani nie używać pocisków innych niż dostarczone z zabawką.
 CZ UPOZORNĚNÍ: Nikdy neupravujte součástky a nepoužívejte jiné projektily než ty, které jsou dodávány s touto hračkou.
 SK UPOZORNENIE: Nikdy neupravujte súčiastky a nepoužívajte iné projektily než tie, ktoré sú dodávané s touto hračkou.
 HU FONTOS: Az elemeket nem szabad módosítani, és a játékhöz adott lövedékek helyett sem szabad másat használni.
 UA ВАЖЛИВО: забороняється вносити зміни до елементів або використовувати інші снаряди на відміну від тих, що поставляються з цією іграшкою.
 HR VAŽNO: Nemojte nikad mijenjati elemente ili koristiti druge projektilе osim onih koji su bili priloženi uz ovu igračku prilikom kupnje.
 SR Важно: Немојте да модификујете елементе и не користите друге пројектиле осим оних који долазе уз ову играчку.
 SL POMEMBNO: Nikoli ne spreminjajte elementov in uporabljajte le izstrelke, ki so bili priloženi tej igrači.
 RO IMPORTANT: Nu modificați niciodată elementele și nu utilizați alte proiectile decât cele furnizate cu această jucărie.
 BG ВАЖНО: Не видоизменяйте елементите и не използвайте други снаряди освен приложените към тази играчка.
 LV SVARĪGĪ! Nekad nepārveidojiet rotallietas elementus, vienmēr izmantojiet tikai tās komplektā iekļautās lodītes.
 ET OLULINE: Mänguosa ei tohi teistega asendada, kasutada võib ainult kaasasolevat heitkeha.
 LT DĖMESIO! Niekuomet nekeiskite elementų ir naudokite tik tuos šovinius, kurie yra pridėti prie šio žaislo.
 TR ÖNEMLİ: Hiçbir zaman parçalarda değişiklik yapmayın veya bu oyuncakla sağlananlar dışında mermiler kullanmayın.

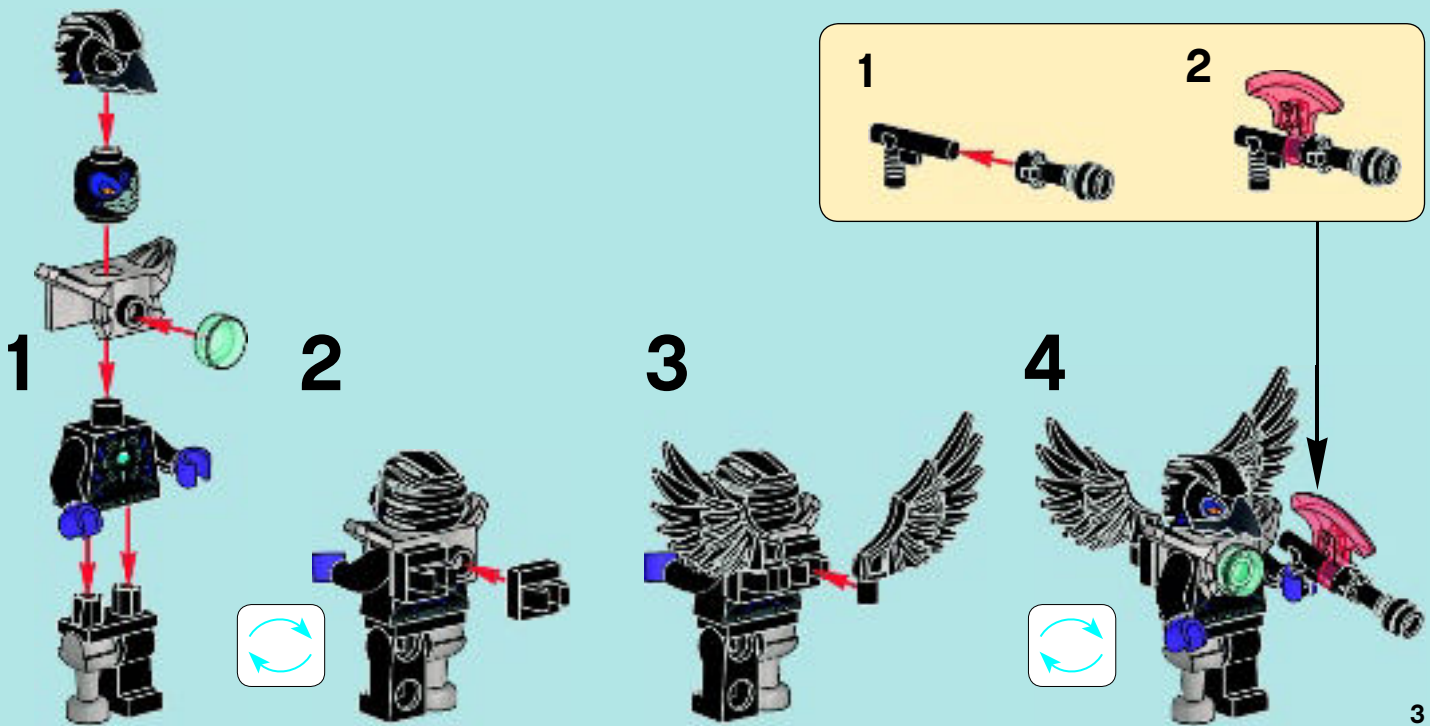
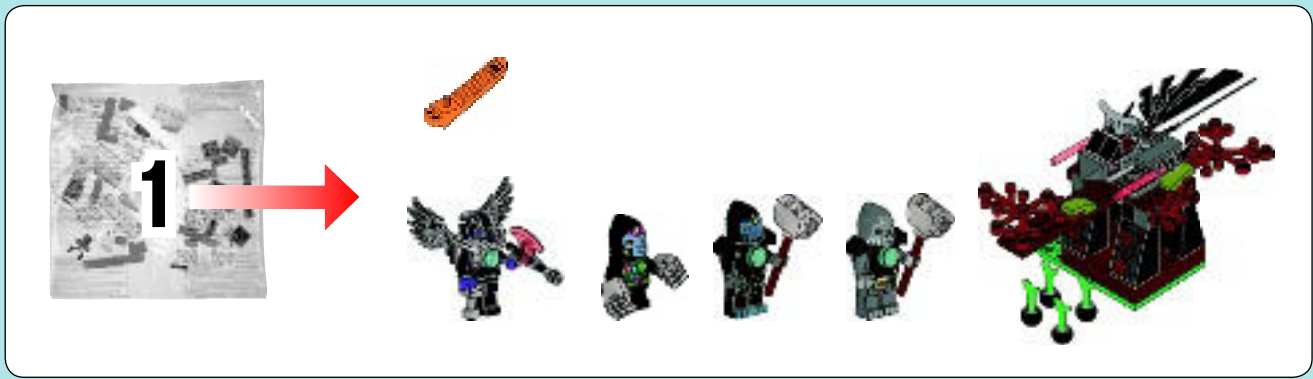

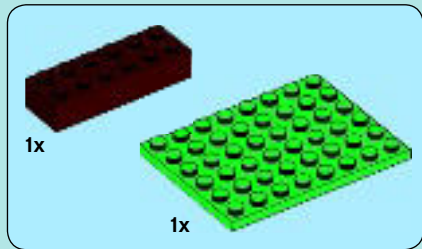
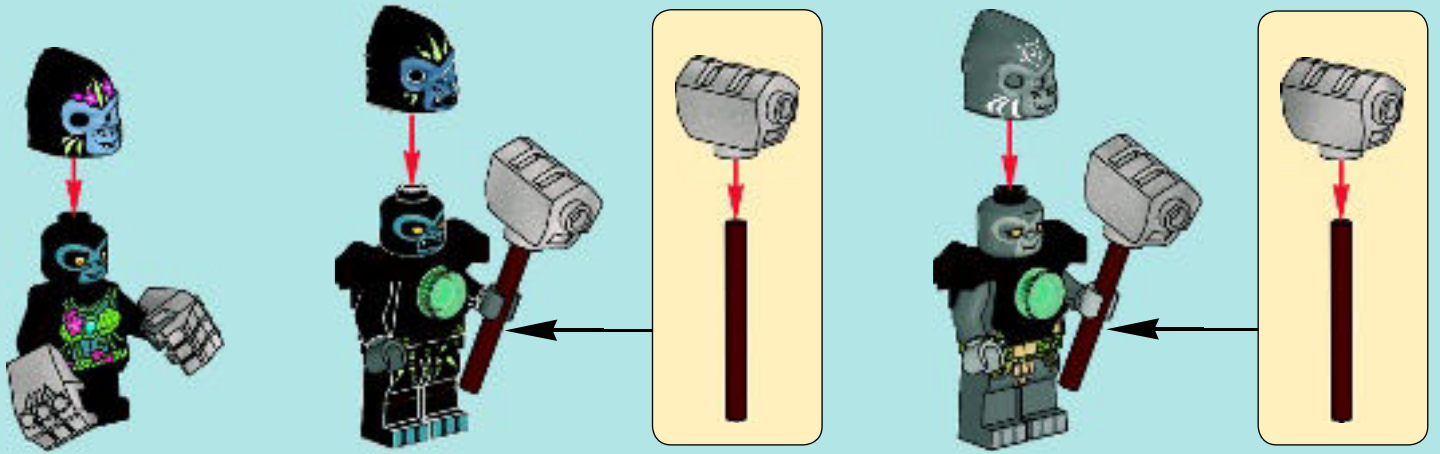

1

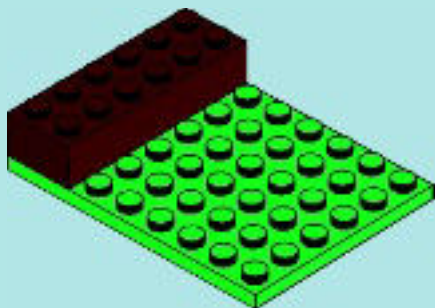

2



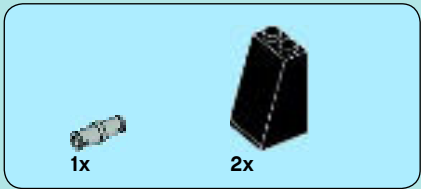

3

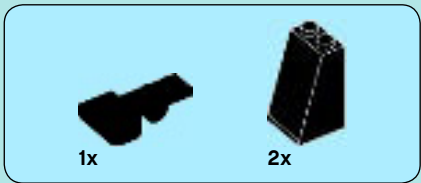
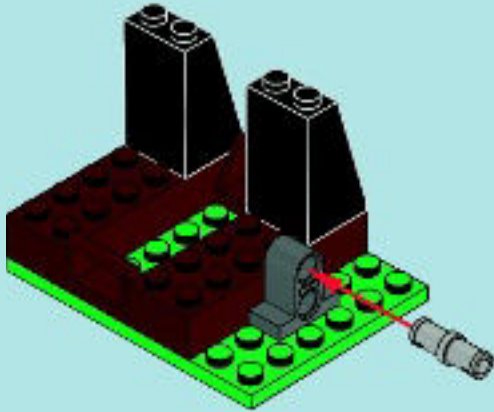

4

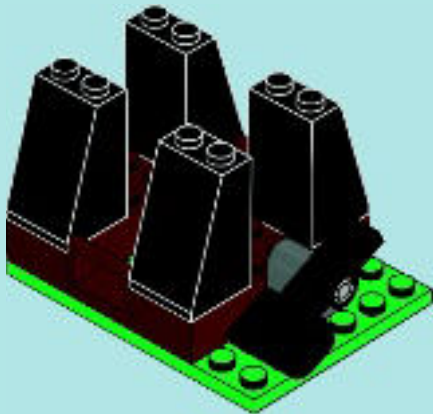

5

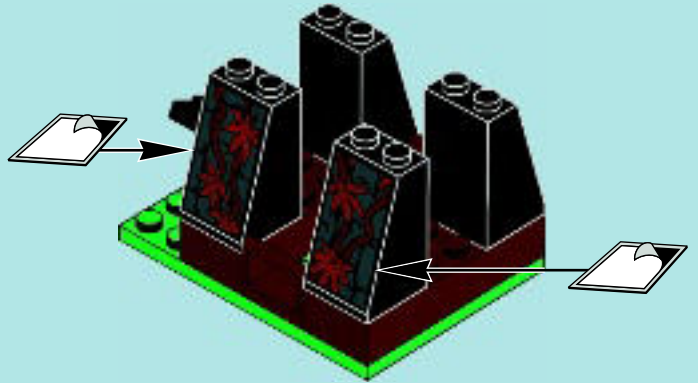
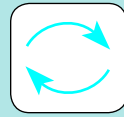

6

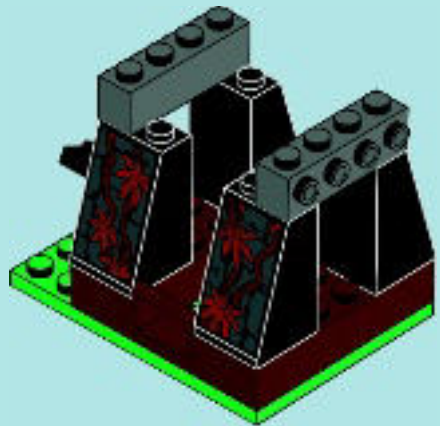



7

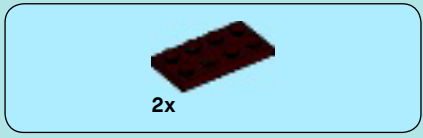
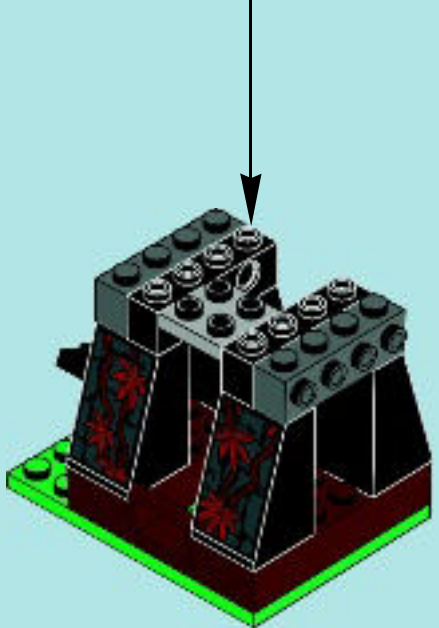
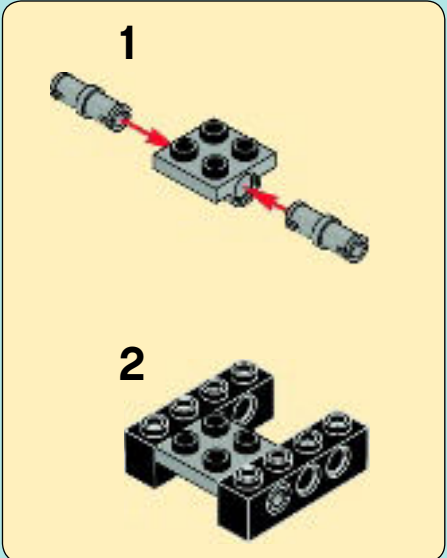

8

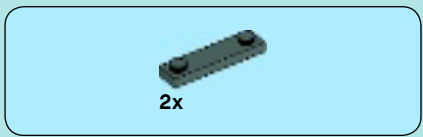
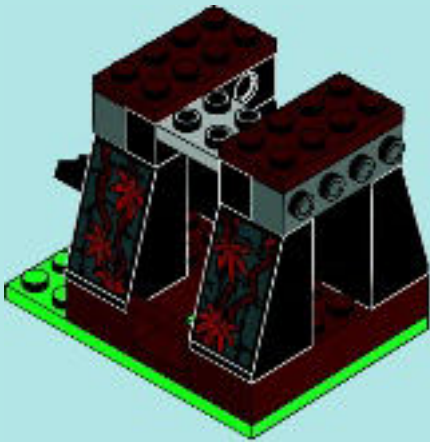

9

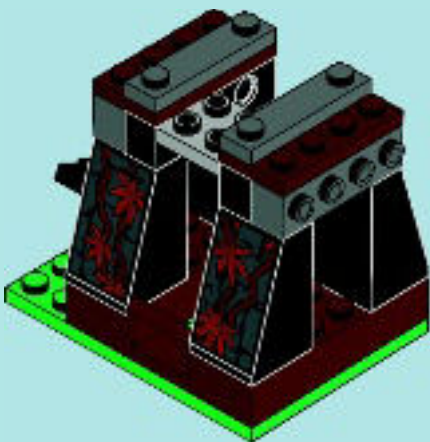

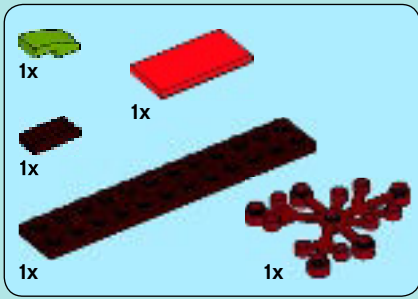

10

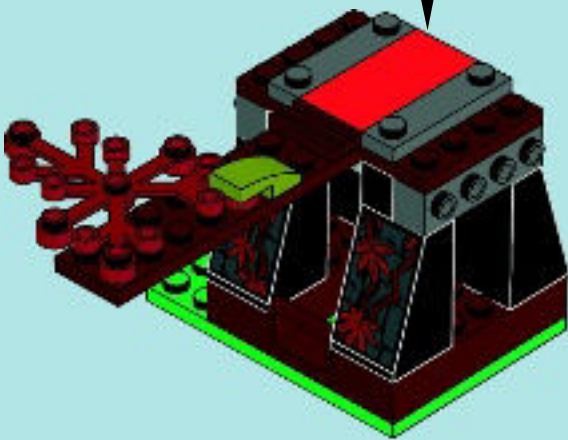
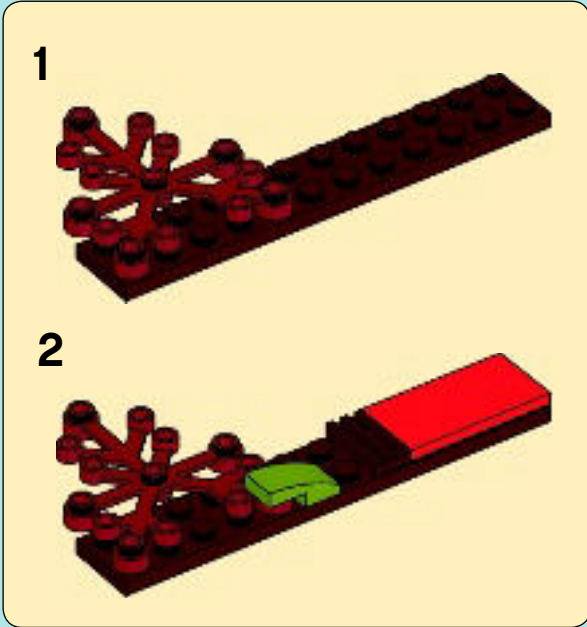

11





12

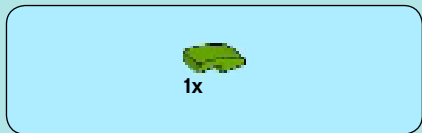

13



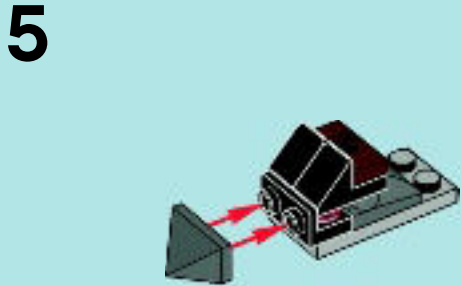
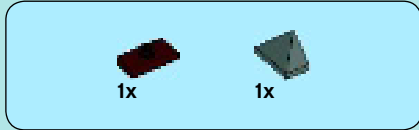
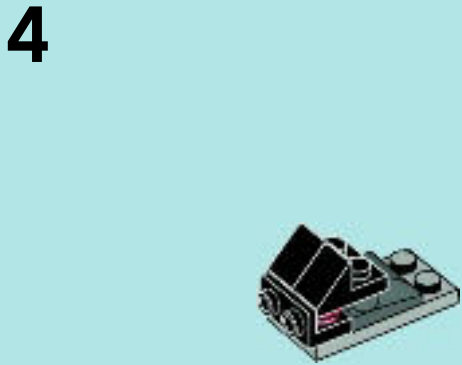
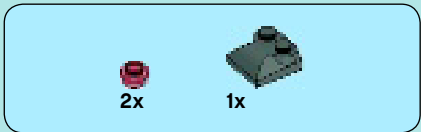
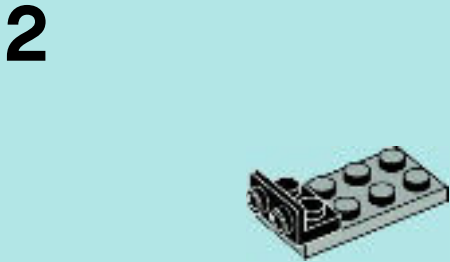
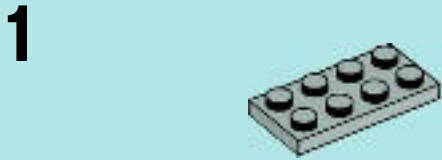



1x

7



2x

8



2x

9



2x



2x

10

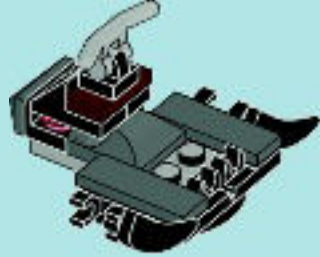

2x



2x

11

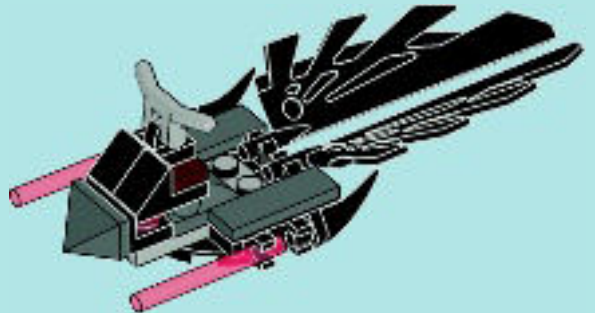

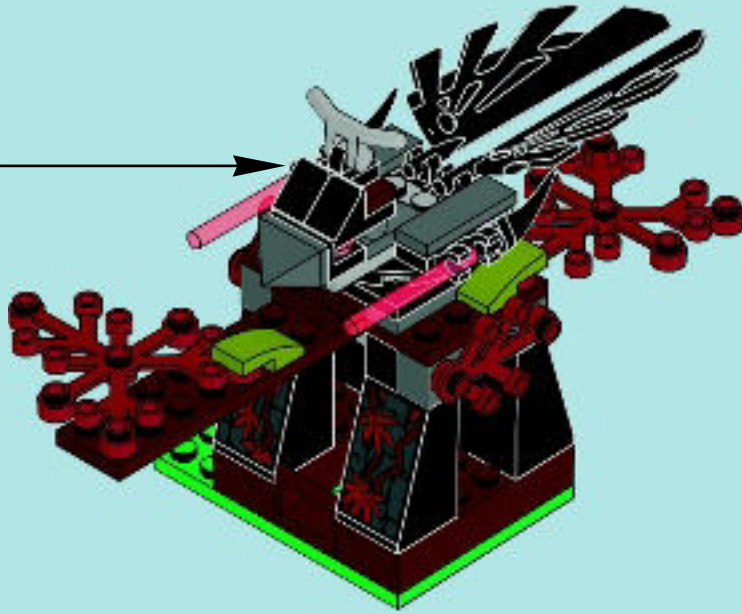

14



4x  4x 

15



 
4x



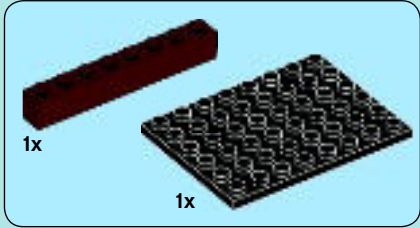
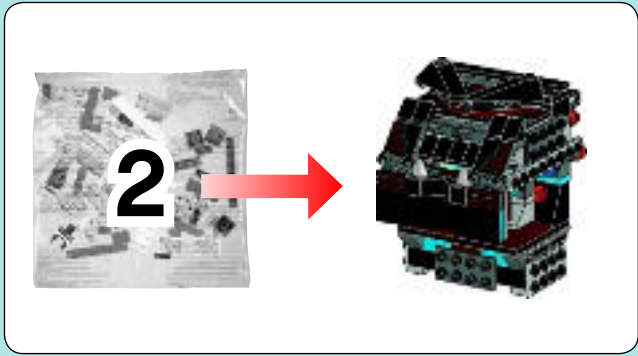

1

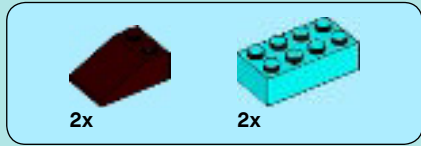
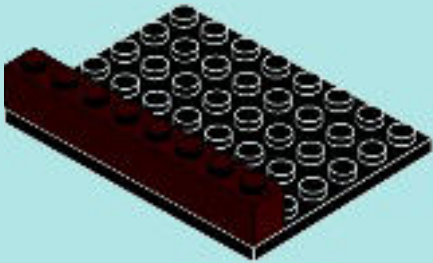

2

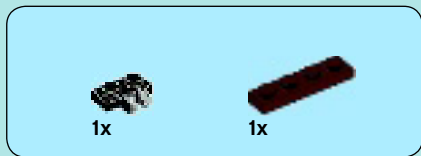
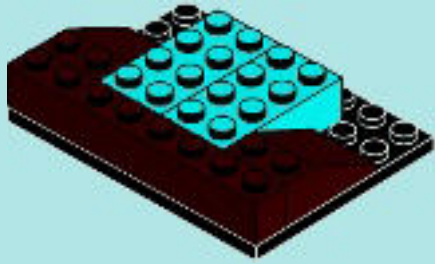

3

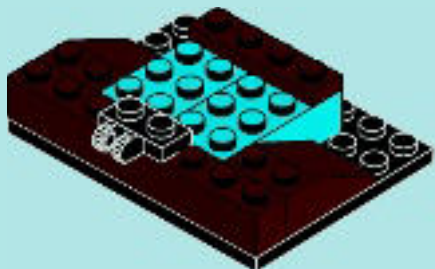

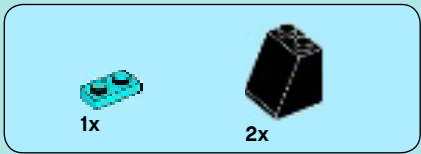

4

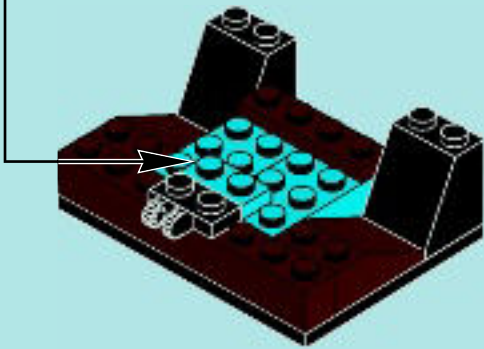

5

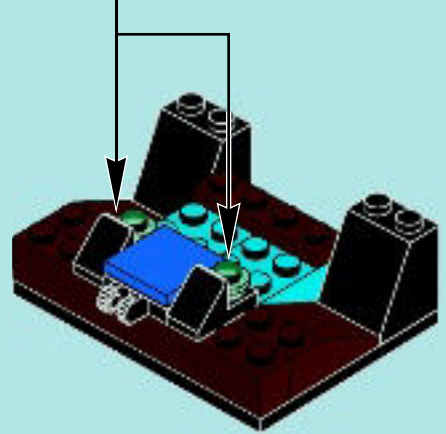

6

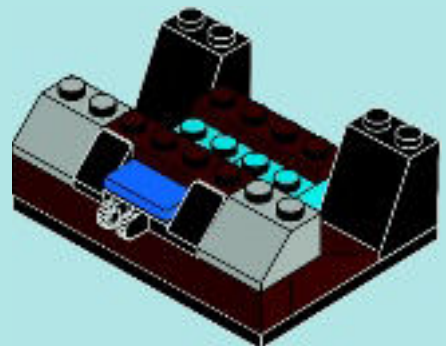

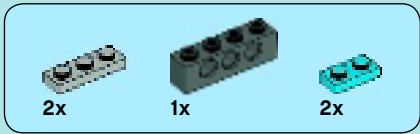

7

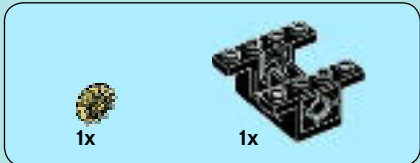
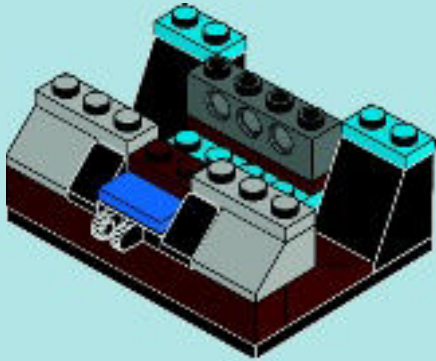

8

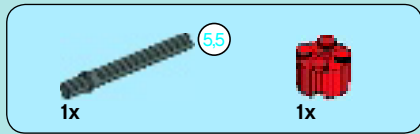
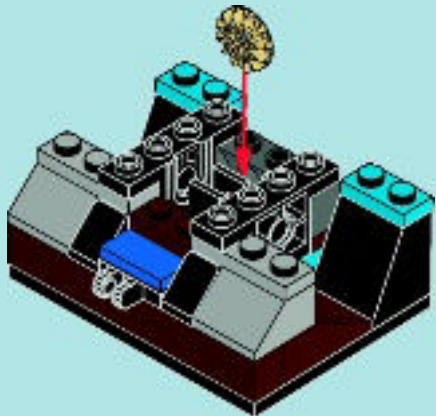

9

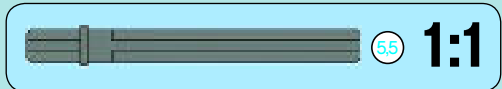
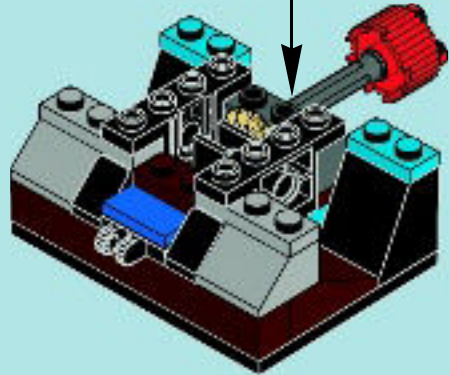
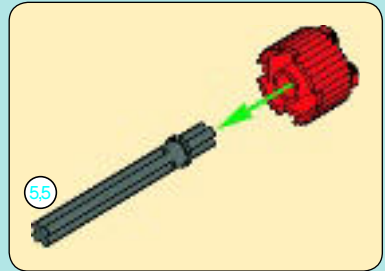



10

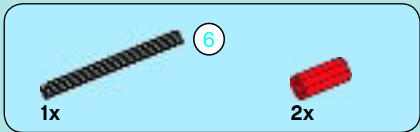
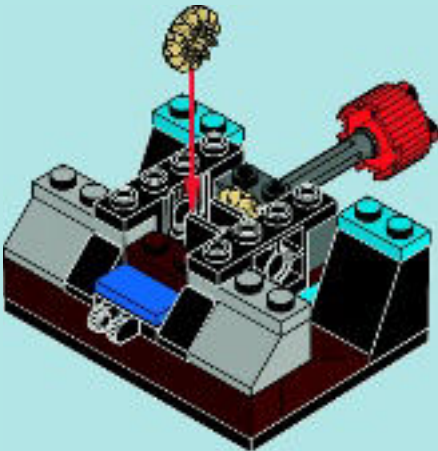

11

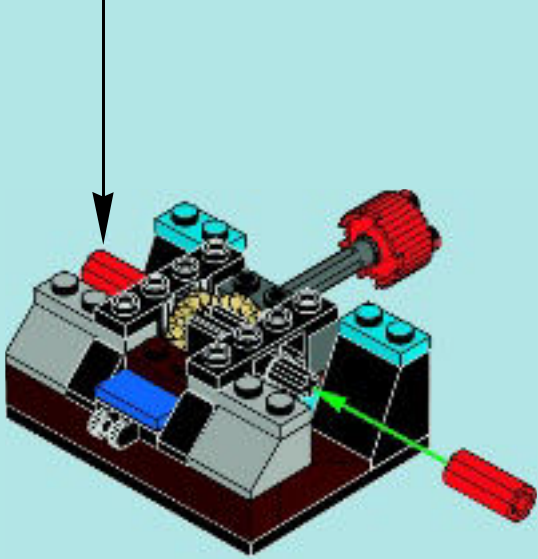
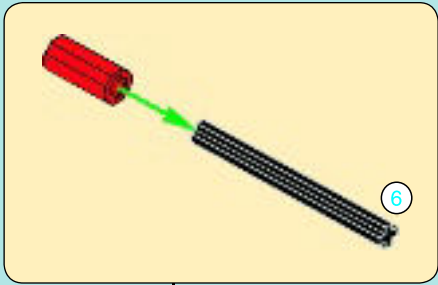

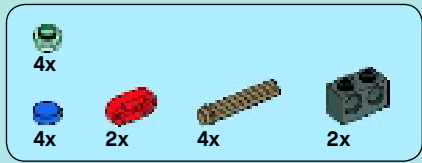

12

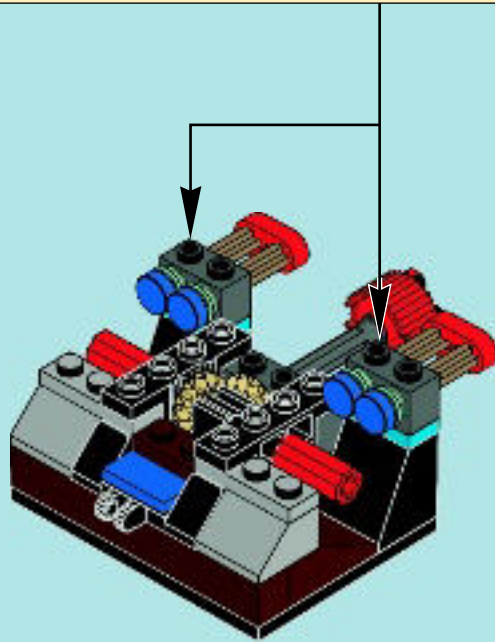
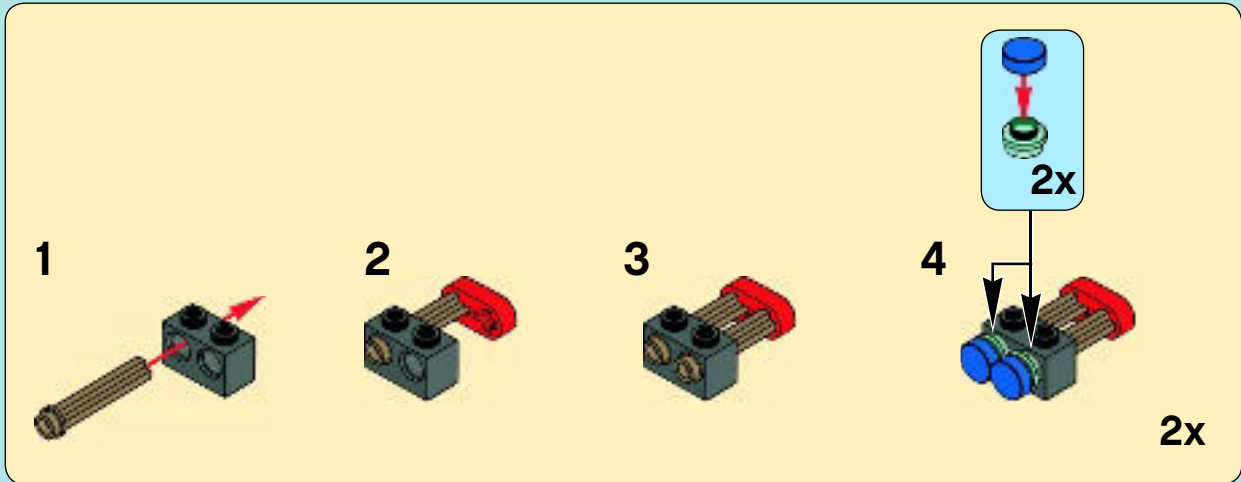

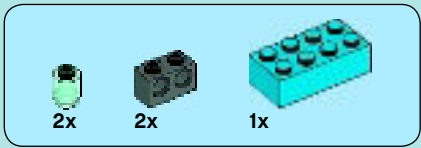

13

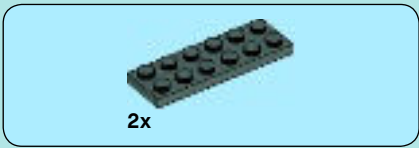
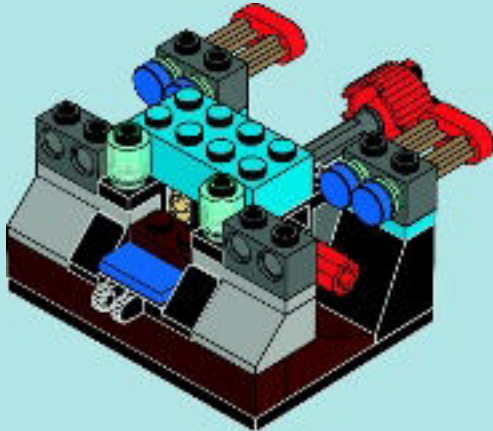

14

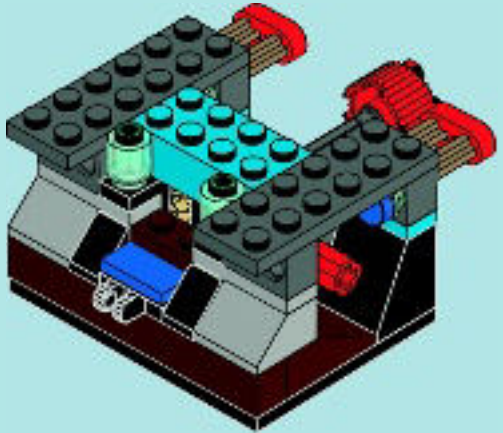

15

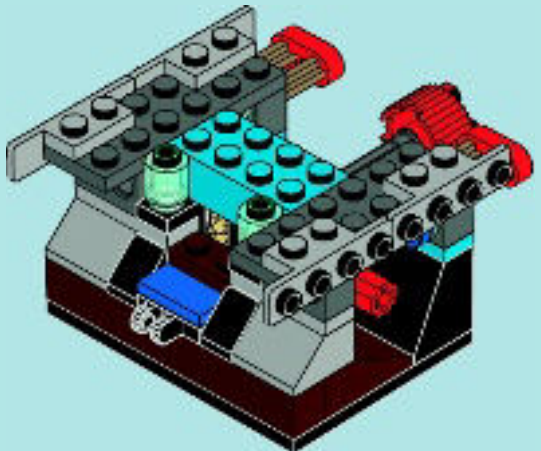



16

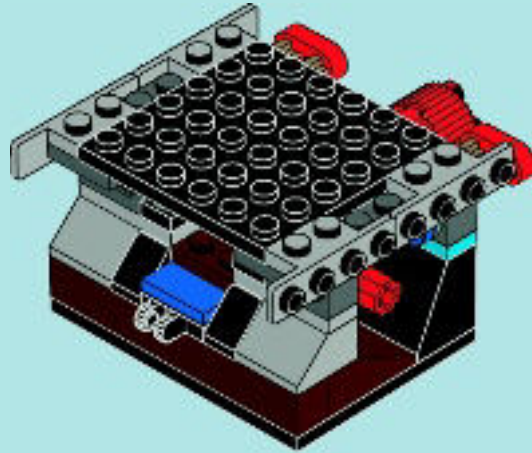

17

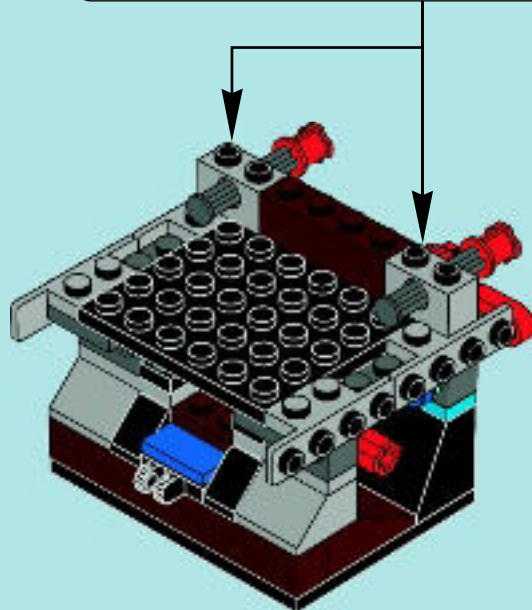
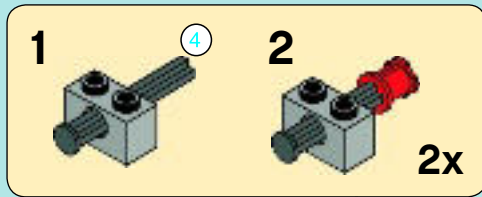



18

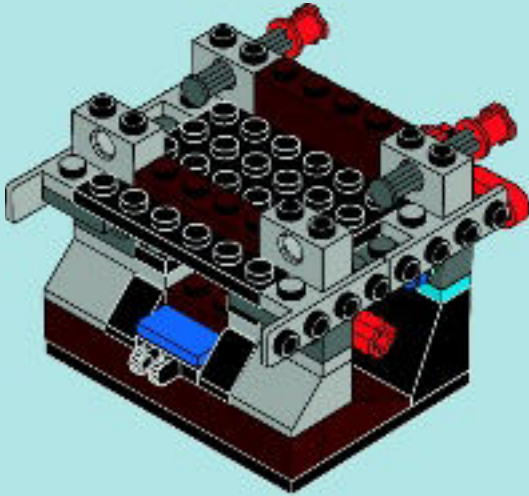

19

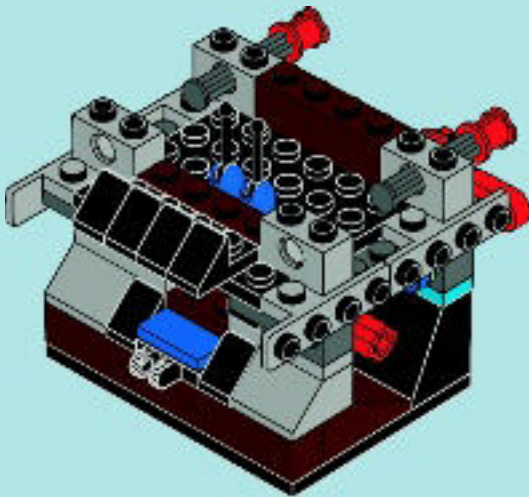

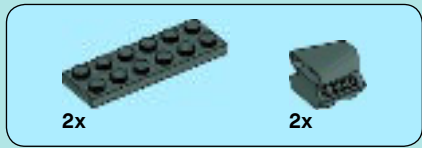

20

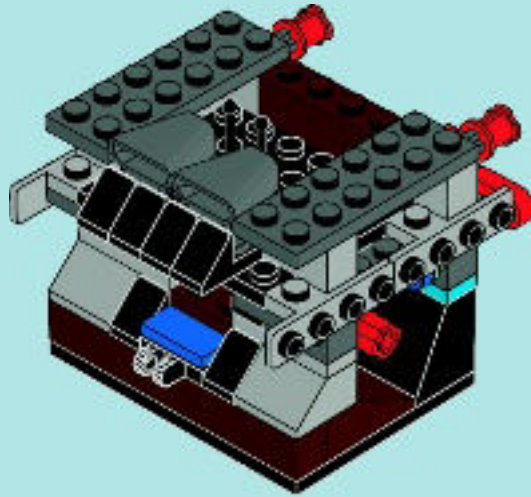

21

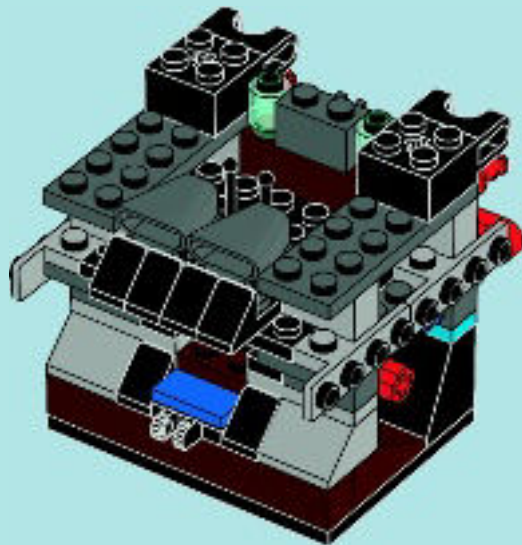



22

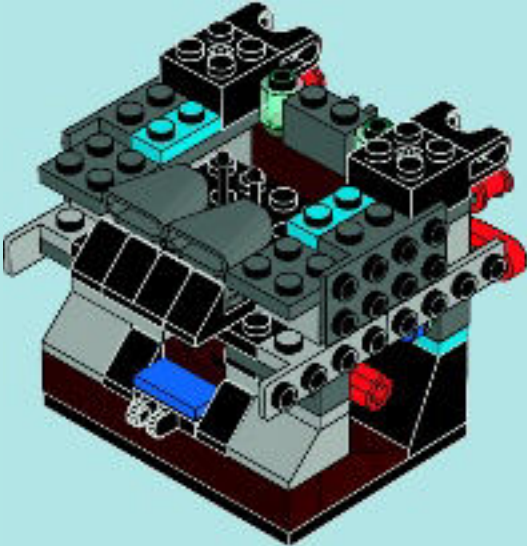

23

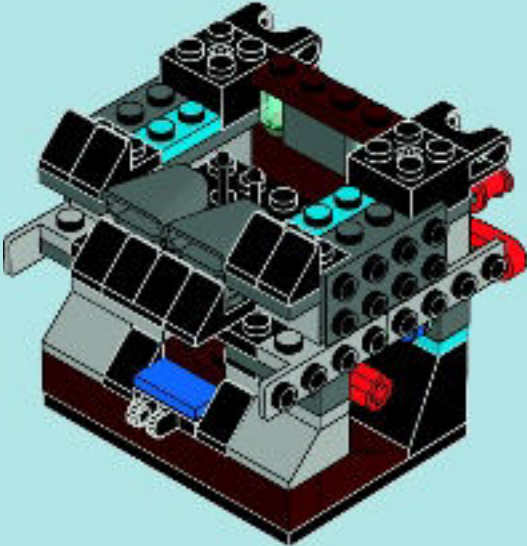

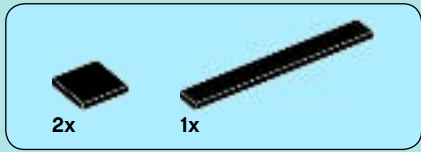

24

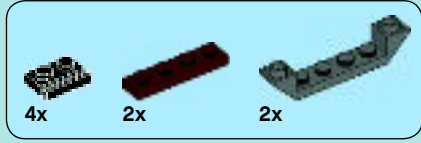
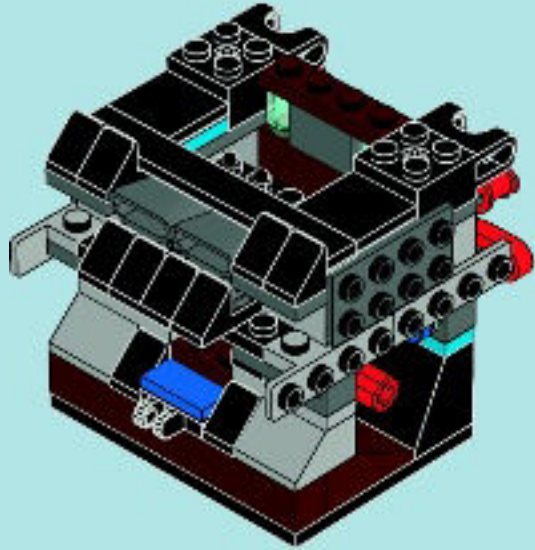

25

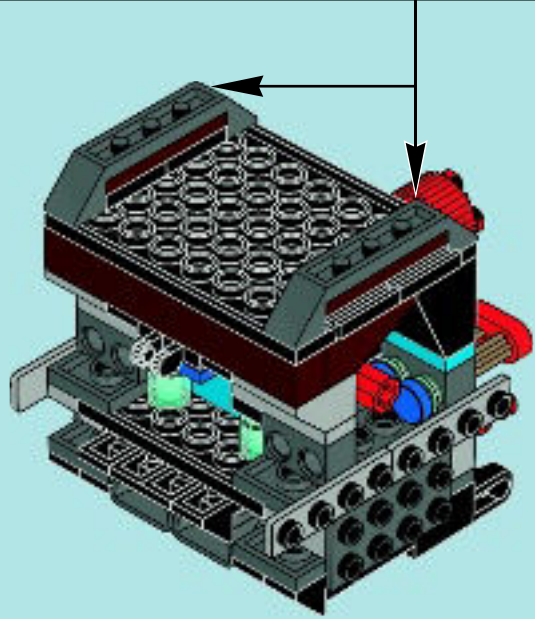
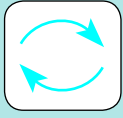
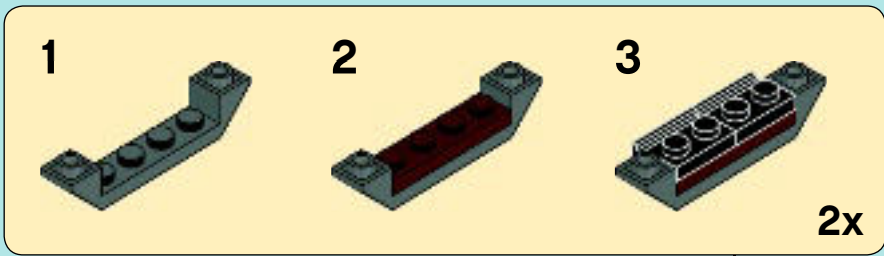

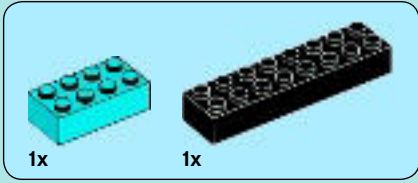

1

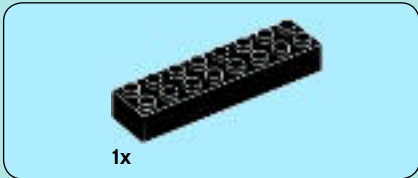
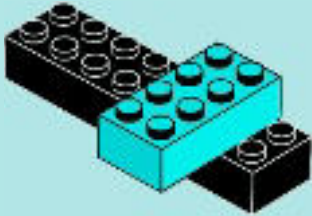

2

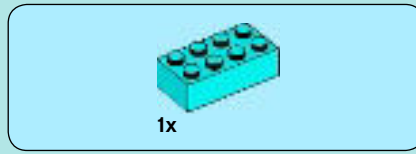
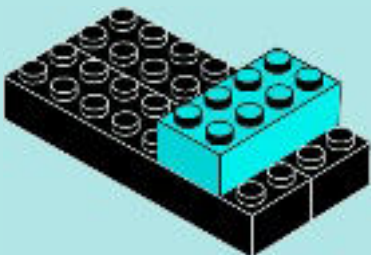

3

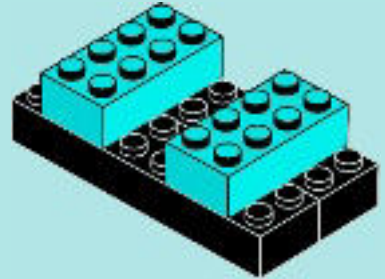

4

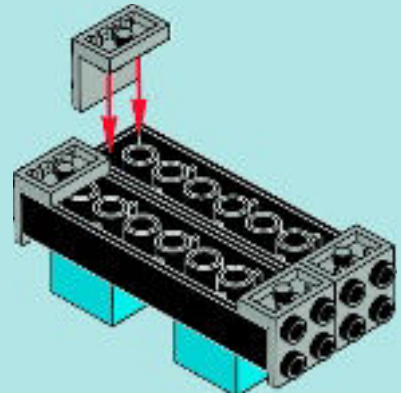
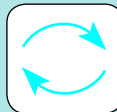



2x

5

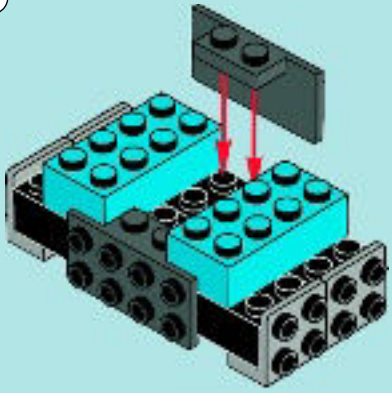
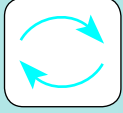

1x

6

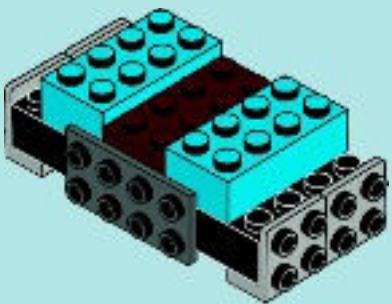

2x

7

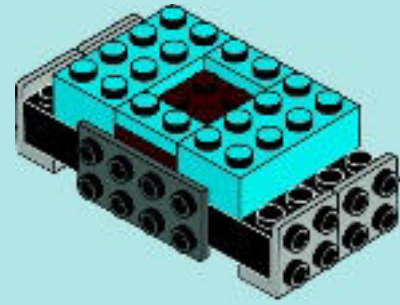

26

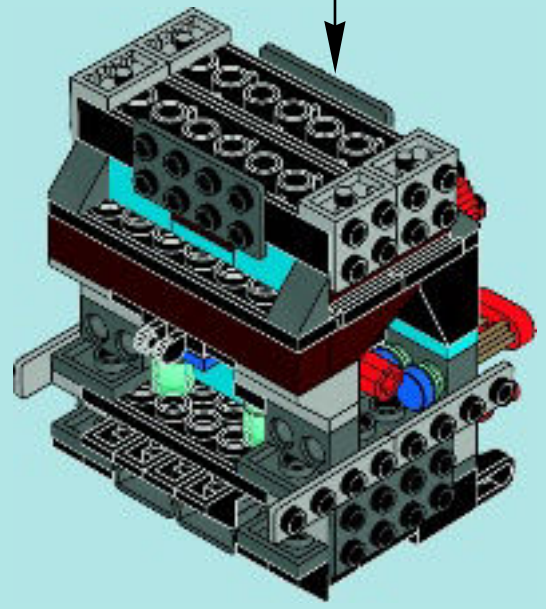

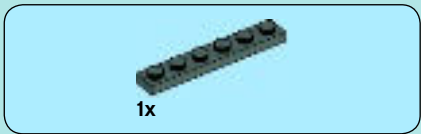

27

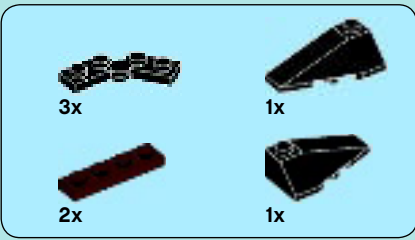
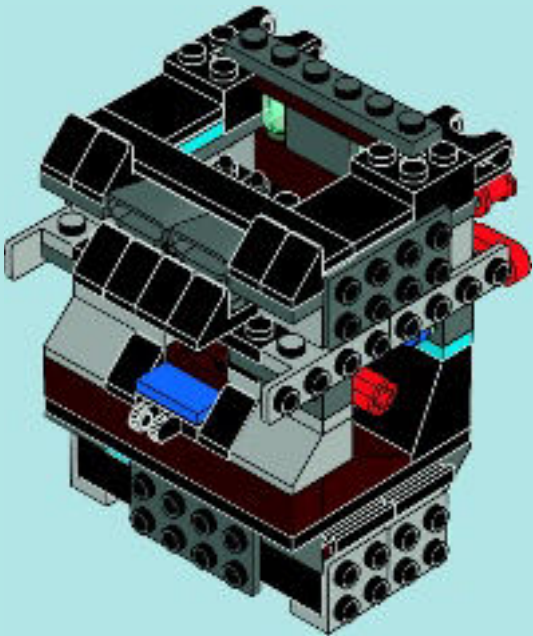

28

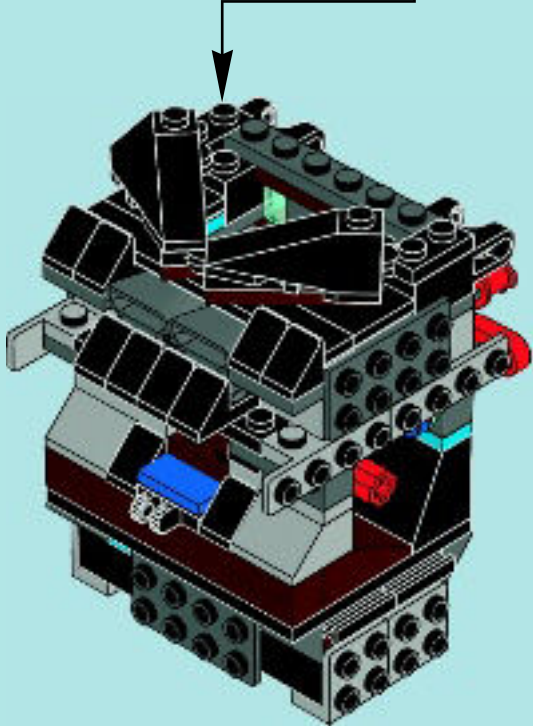
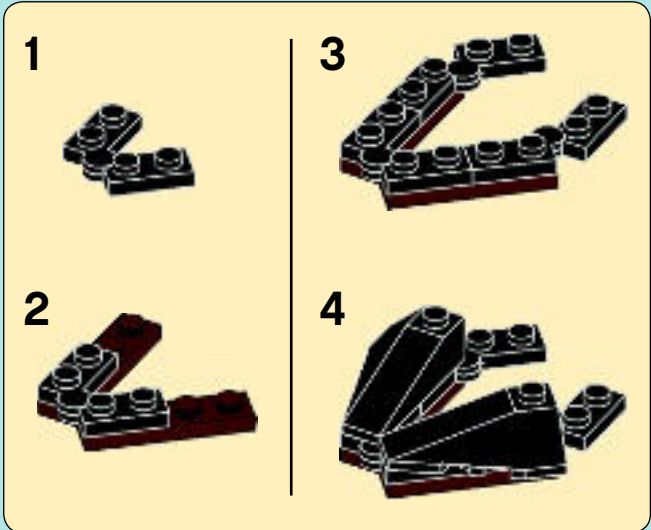

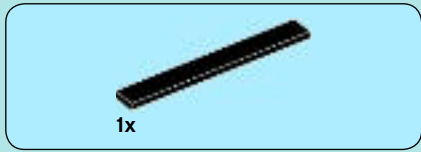

29

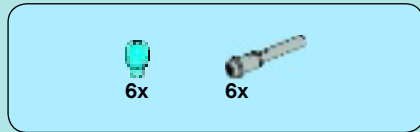
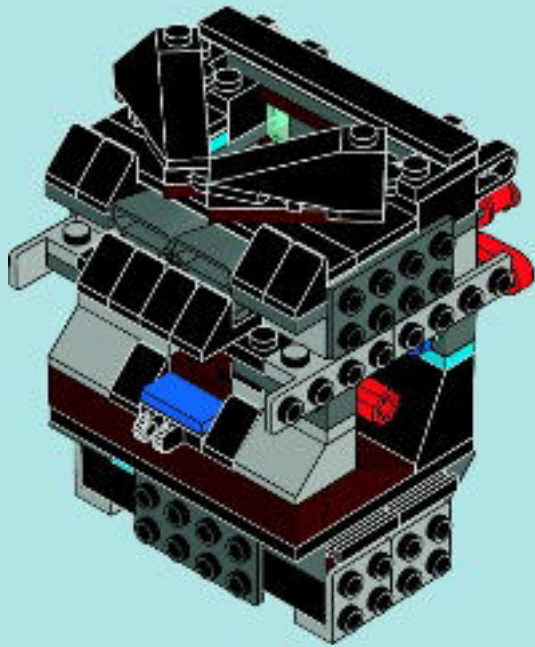

30

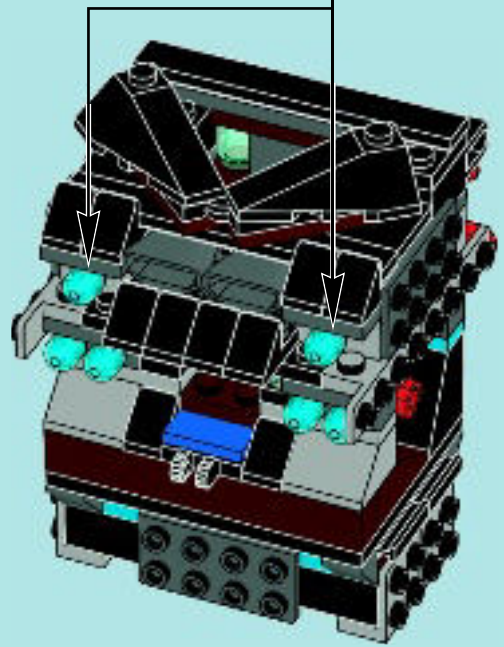
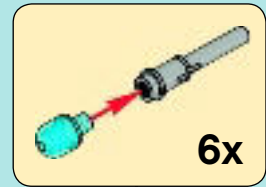



1x

1

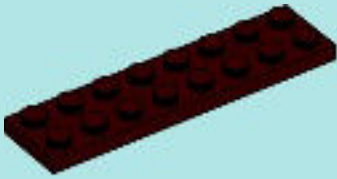

2x

2x

2



2x

2x

3

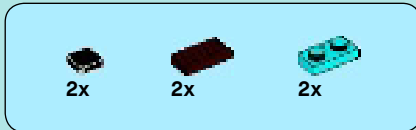
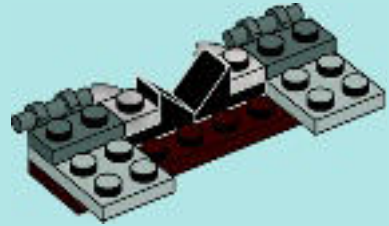

2x

2x

2x

4

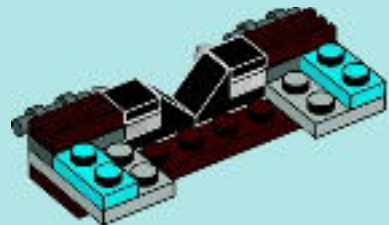

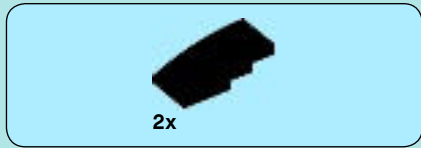

5

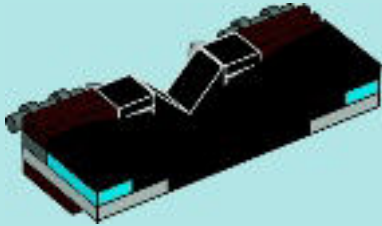

6

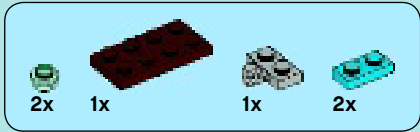
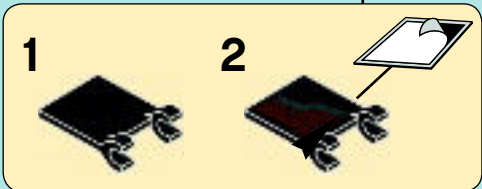
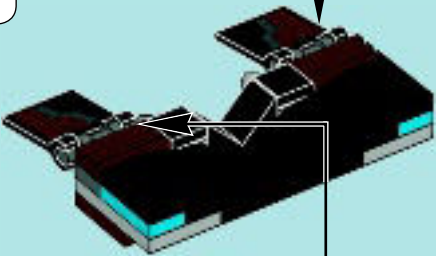

7

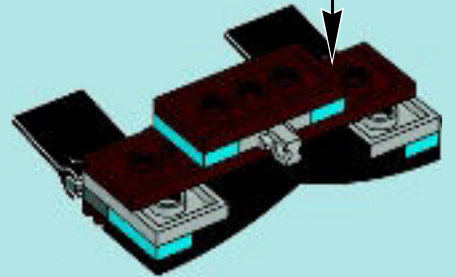
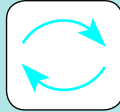
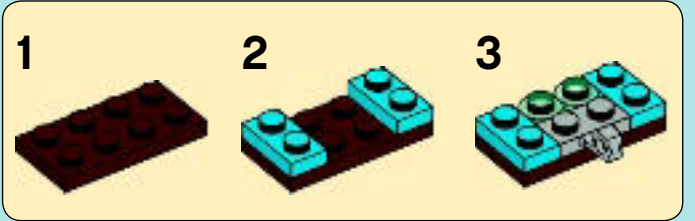

8

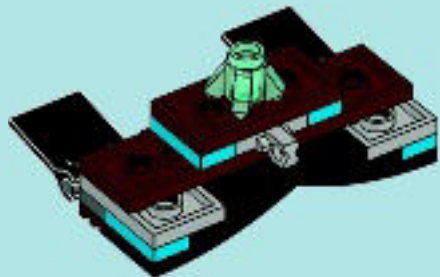

31

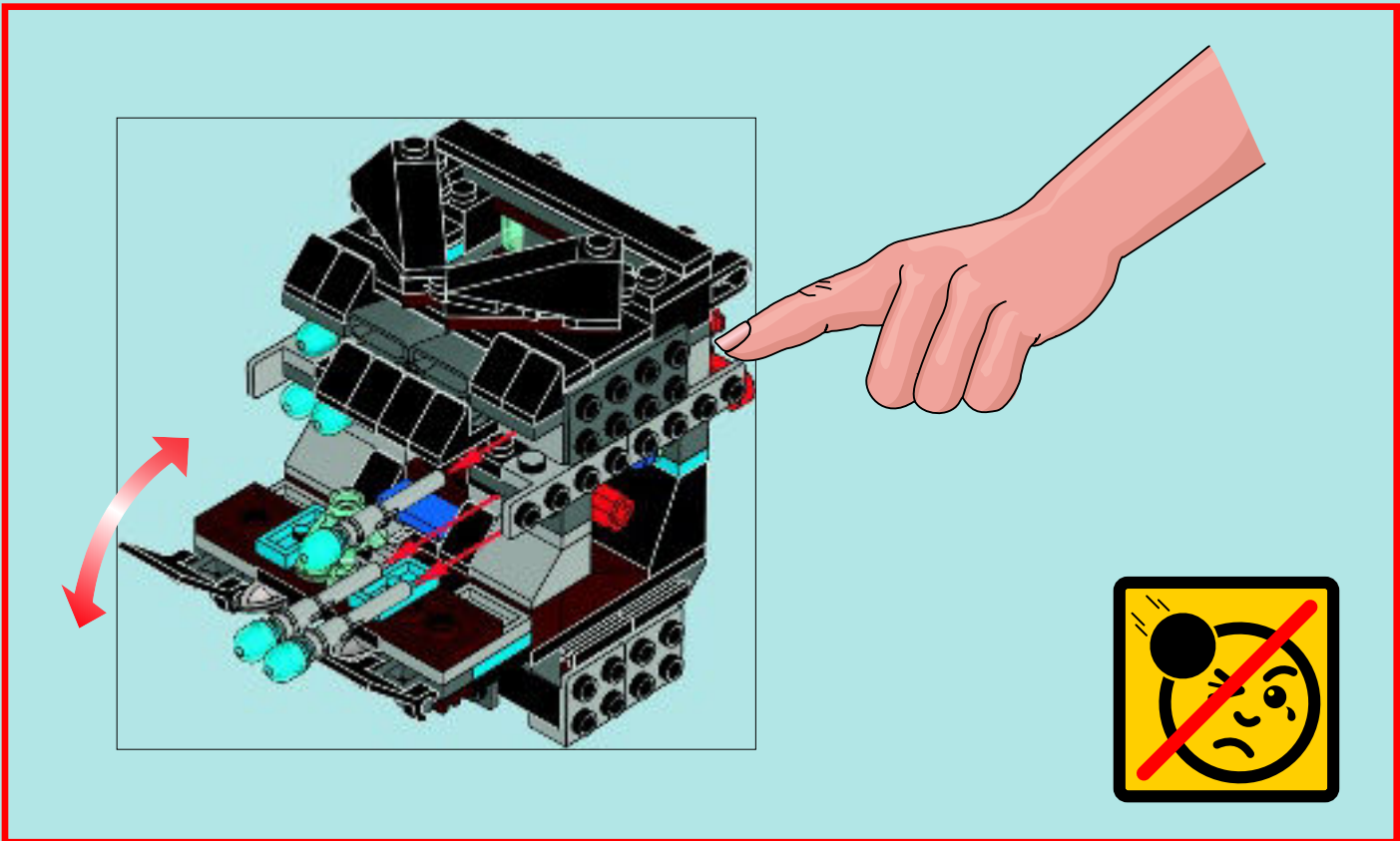
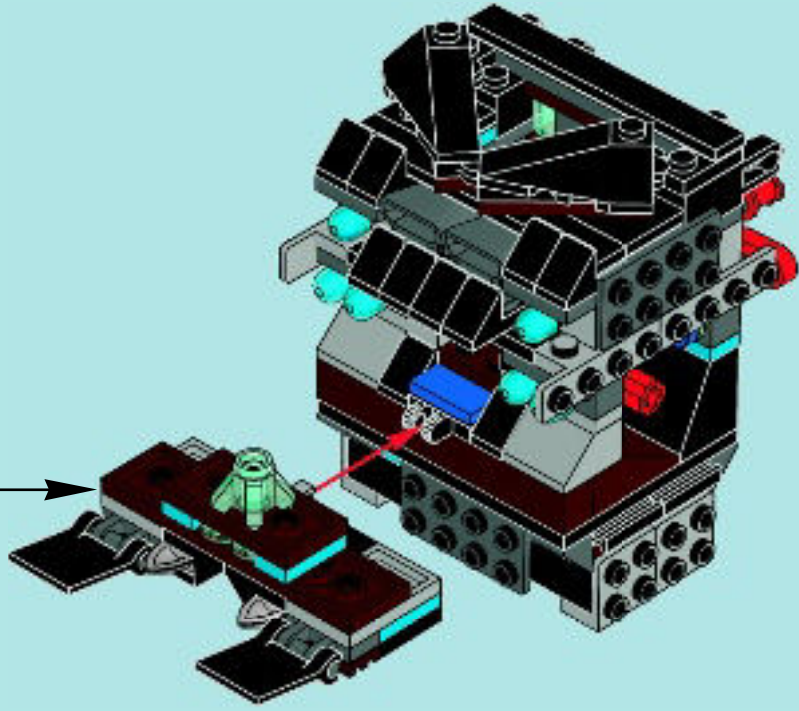

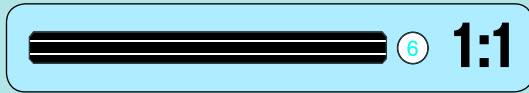
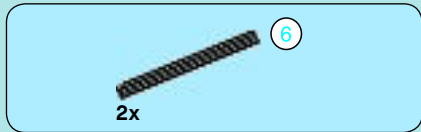
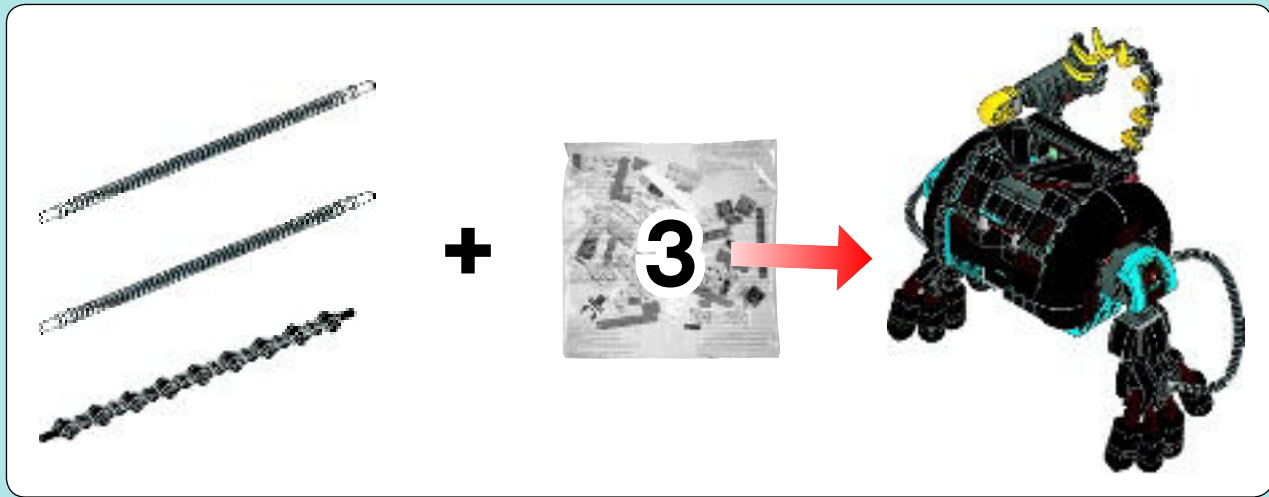

32

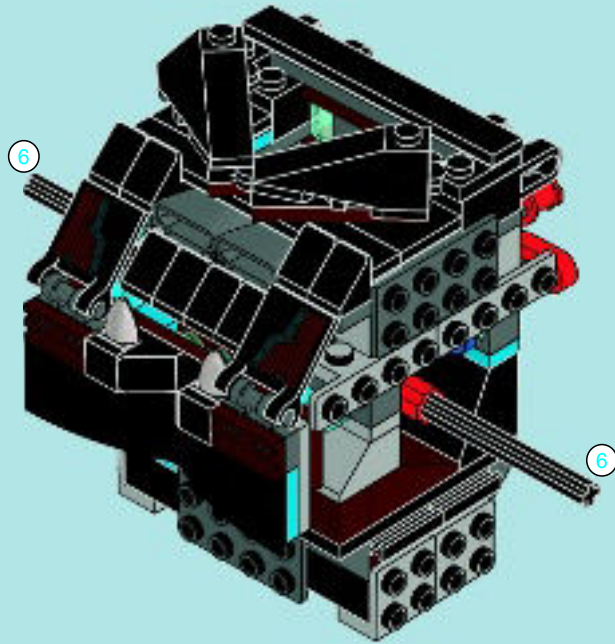



4x

33



2x

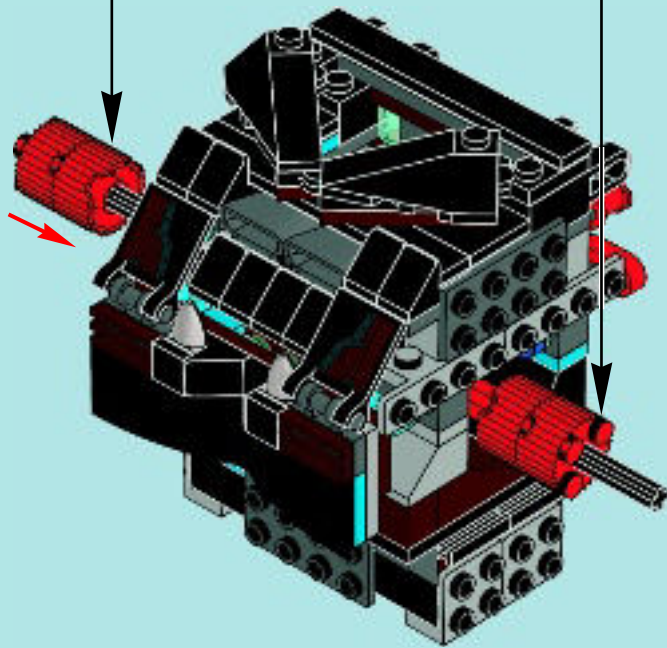

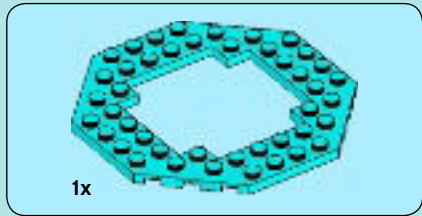
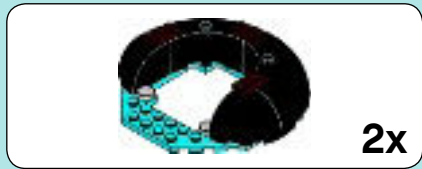

1

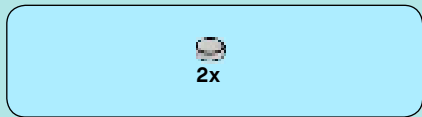
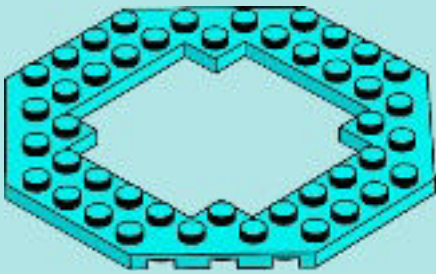

2

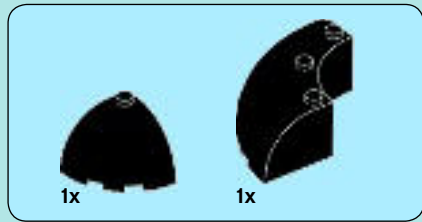

3

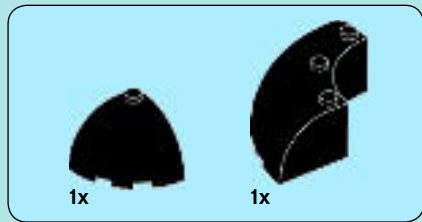
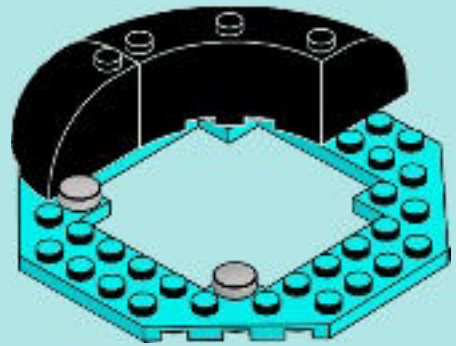

4

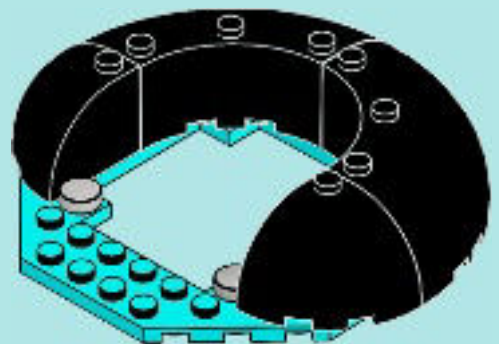



LEGENDS OF CHIMA™

CHIMA

WATCH THE VIDEO

WATCH THE VIDEO · SEH DIF DUA VIDEOS
REGARDE LA VIDEO · MIRA EL VIDEO
VÉ O VIDEO · MIRA MIRA A VIDEO

SCAN THE QR CODE

SCAN THE QR CODE · SCANE DEN QR-CODE
SCANNARE LE QR CODE · CAPTURAR EL CÓDIGO QR
PRZESKAN KÓDQR QR · QLVASO BIE A QR KODOT



LEGO.COM/CHIMA



LEGENDS OF CHIMA™

LAGRAVIS



70010 70108

LAVAL



70005
70010 70115

LONGTOOTH



70005
70010 70113

LENNOX



70002
70006 70011
70014 70104

LEONIDAS



70001 70006
70014 70102

FURTY



70111

SKINNET



70107

EWALD



70010 70011

ERIS



70003
70009 70114

EQUILA



70004
70013 70101

EGLOR



70007
70013 70105

EWAR



70012

GRUMLO



70008

G'LDUNA



70008

GURZAN



70008 70109

GRIZZAM



70009 70110

CROMINUS



70006
70014 70103

CRAGGER



70006 70010
70014 70115

CROOLER



70006

CRUG



70002
70014 70112

CRAWLEY



70001
70005 70010

RAWZOM



70006 70114

RAZAR



70003 70010
70012 70100

RIZZO



70003
70008 70012

RAZCAL



70000 70007

WORRIZ



70009 70011

WAKZ



70004
70009 70113

WILHURT



70009 70013

WINDRA



70009

WINZAR



70004 70106



LEGO
LEGENDS OF
CHIMATM

**WATCH THE MODEL
IN ACTION**

ERLEBE DAS MODELL IN AKTION
REGARDE LA DÉMO DU MODÈLE EN ACTION
MIRA EL MODELO EN ACCIÓN
VÉ O MODELO EM AÇÃO
NÉZD MEG A MODELLT MŰKÖDÉS KÖZBEN

SCAN THE QR CODE
SCANNE DEN QR-CODE
SCANNE LE QR CODE
CAPTURA EL CÓDIGO QR
FAZ SCAN DO CÓDIGO QR
OLVASD BE A QR KÓDOT

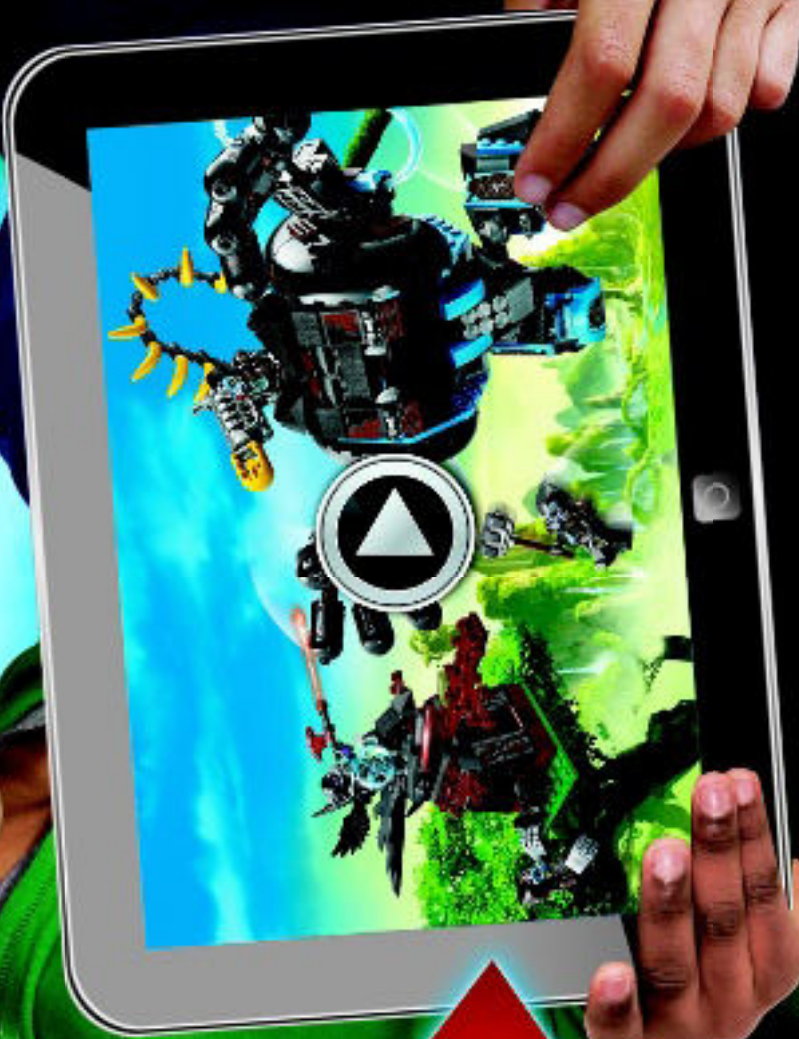

LEGO.COM/CHIMA

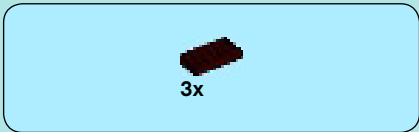

5

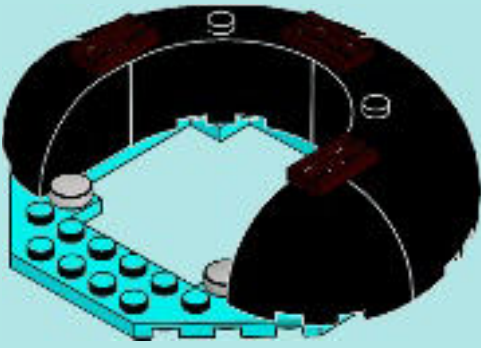

2x

34

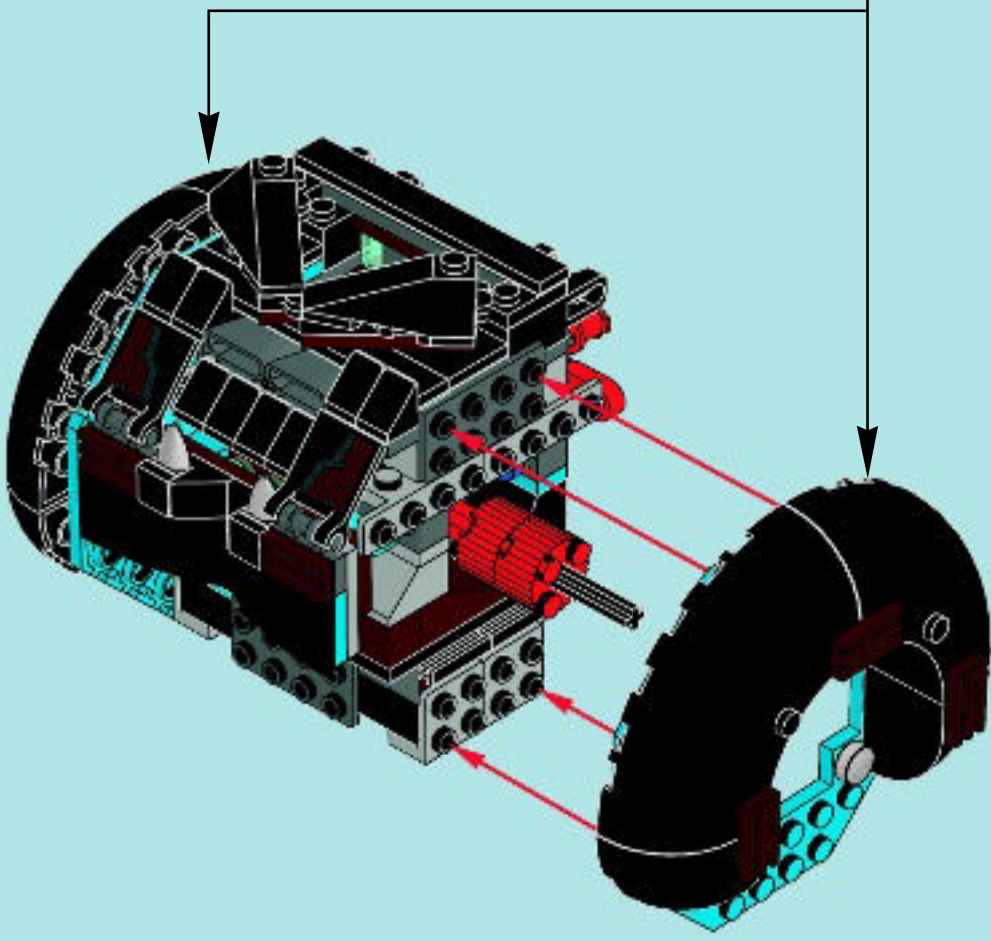



1

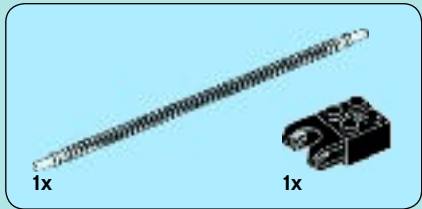

2

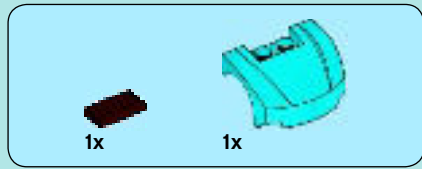
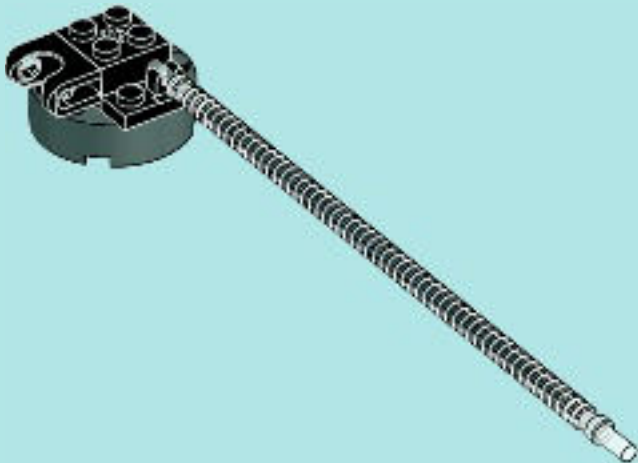

3

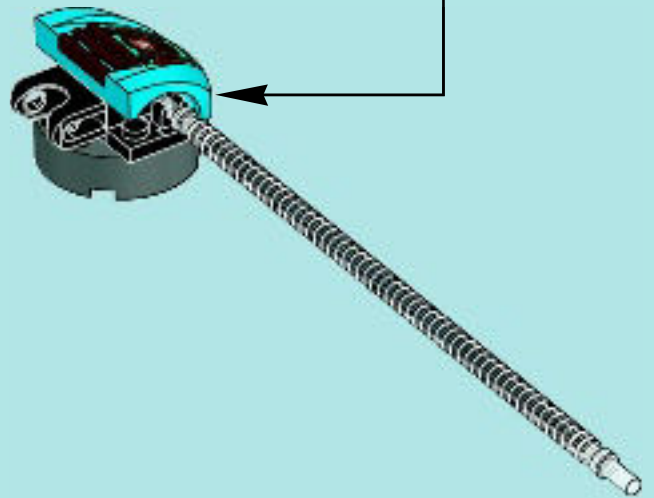
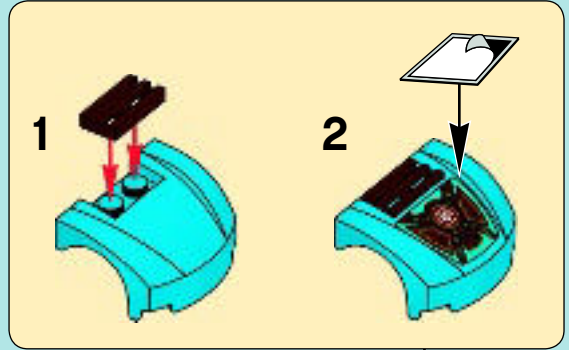

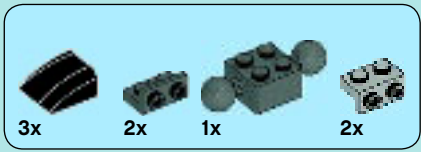

4

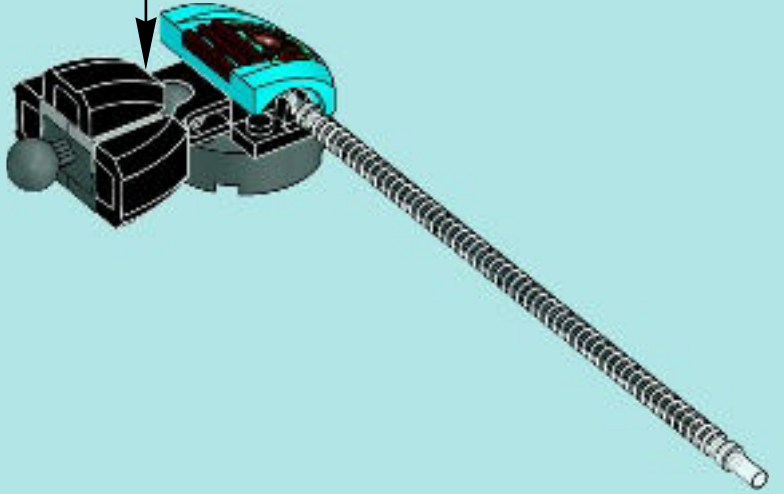
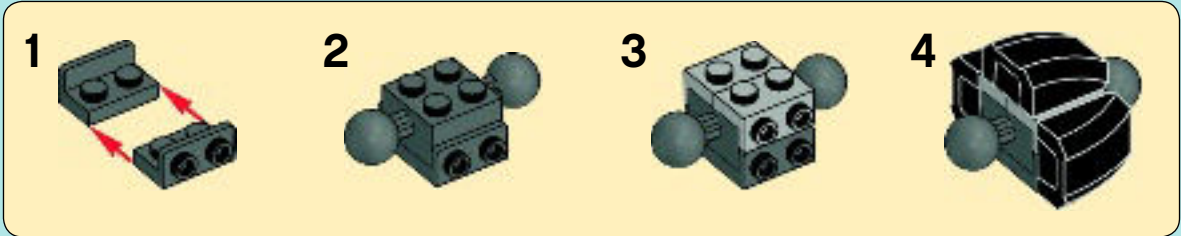

5

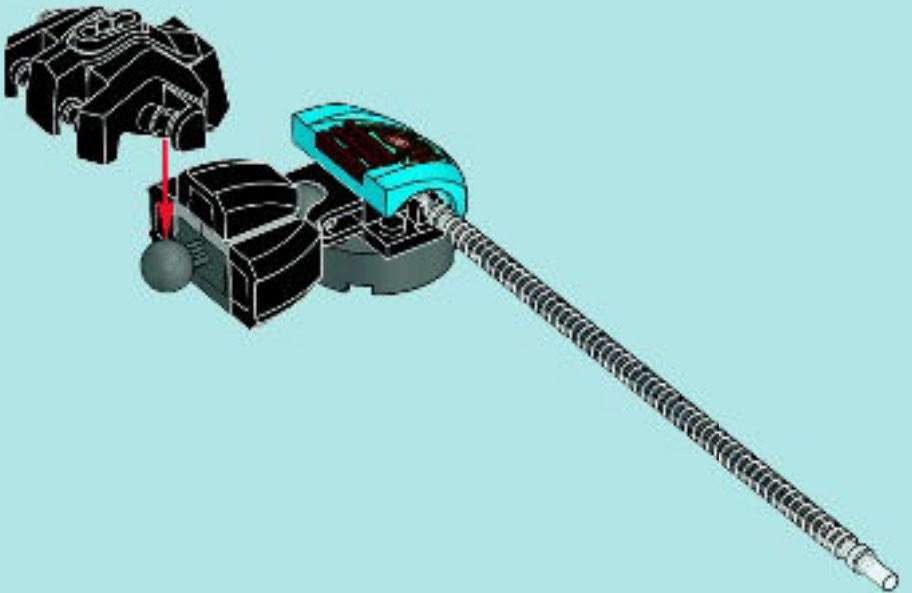

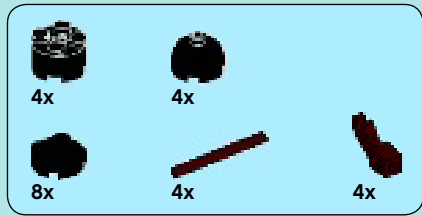

6

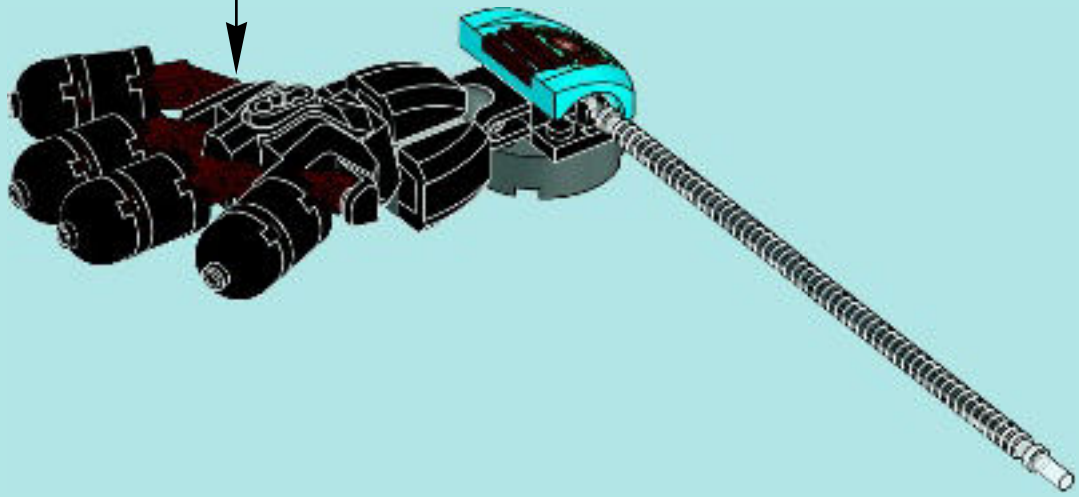
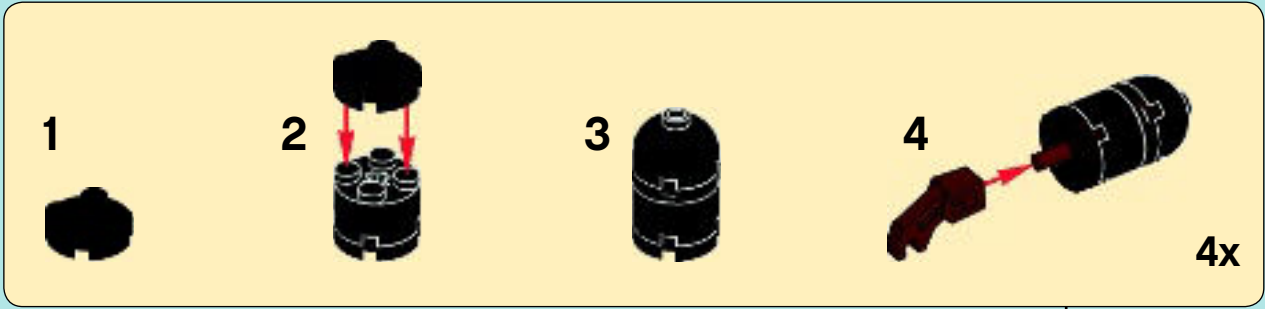

7



35

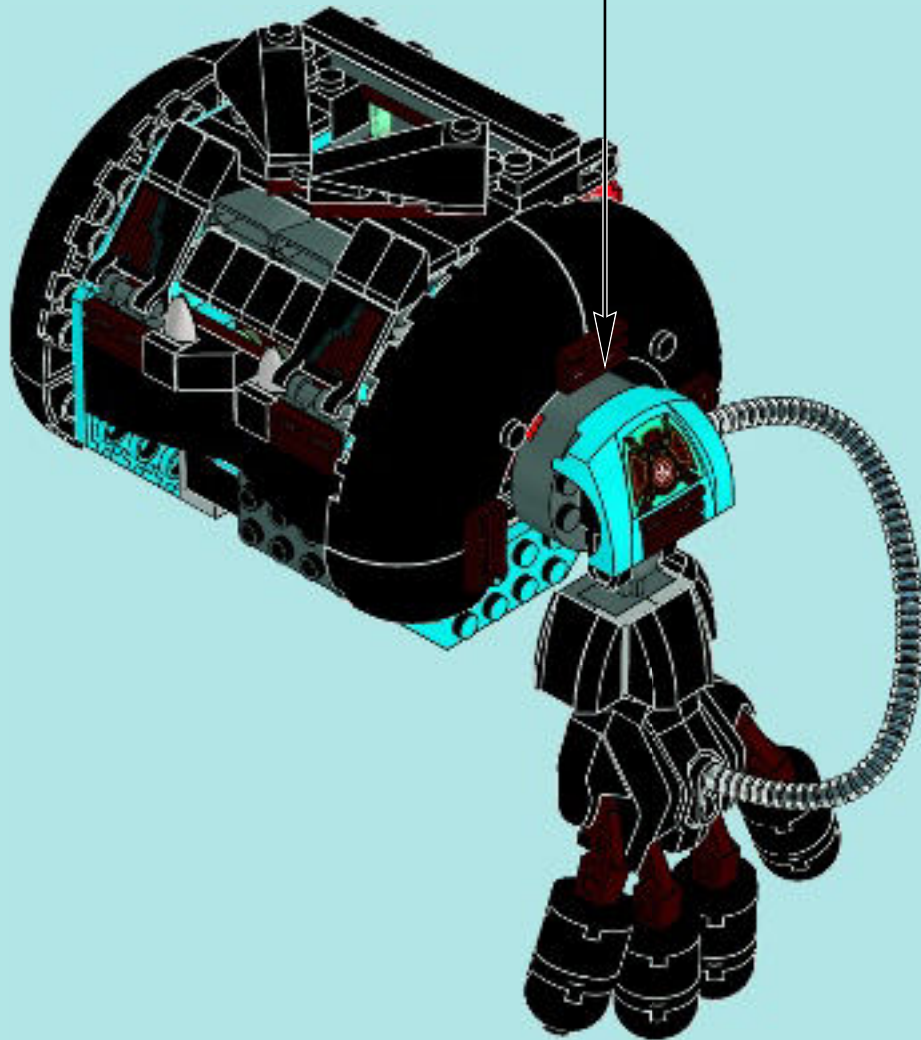



1

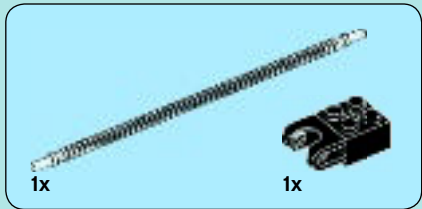

2

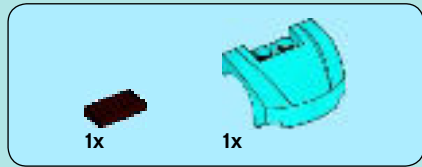
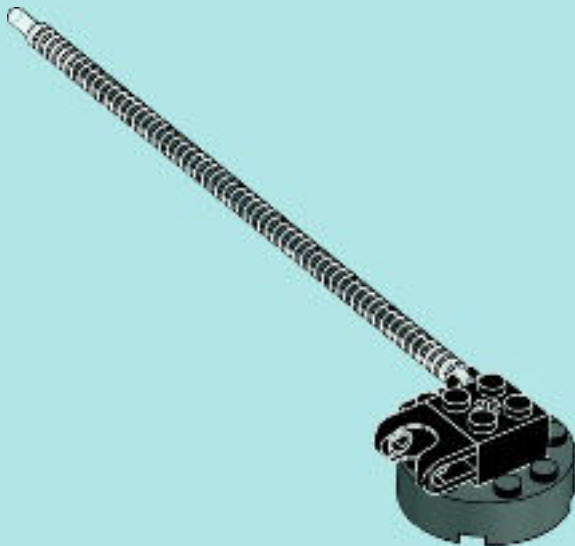

3

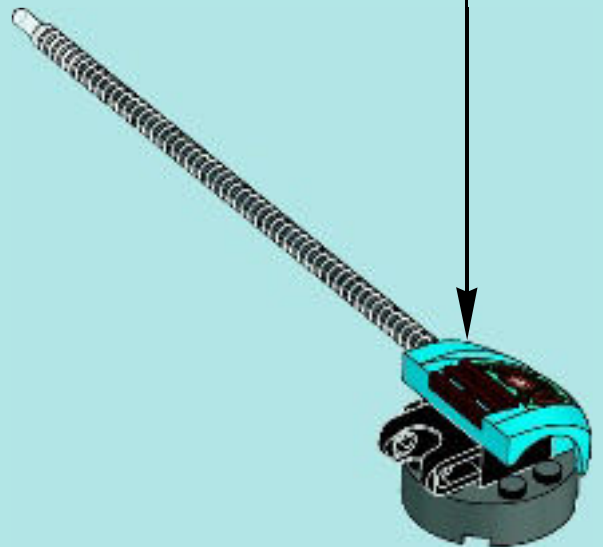
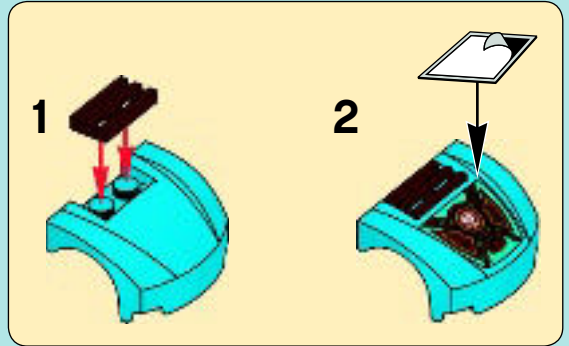

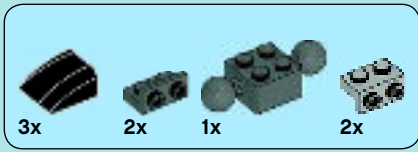

4

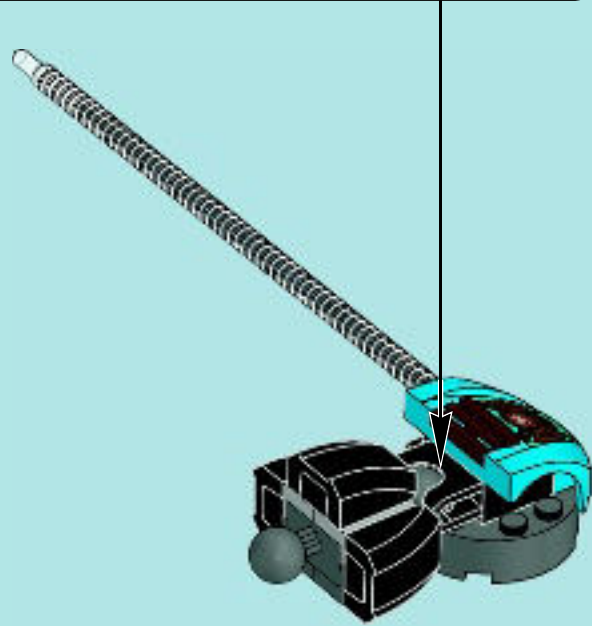
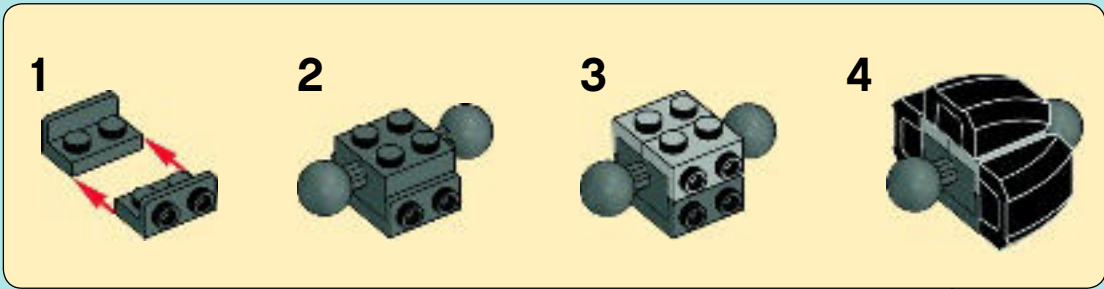

5

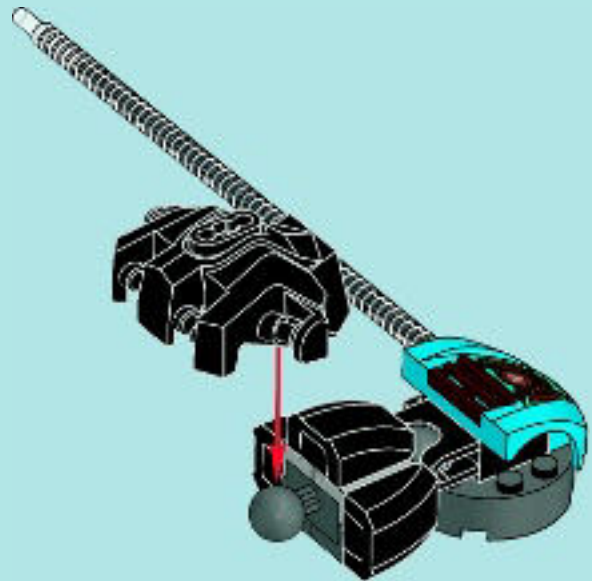

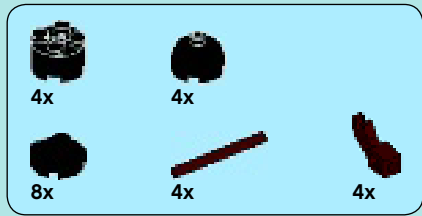

6

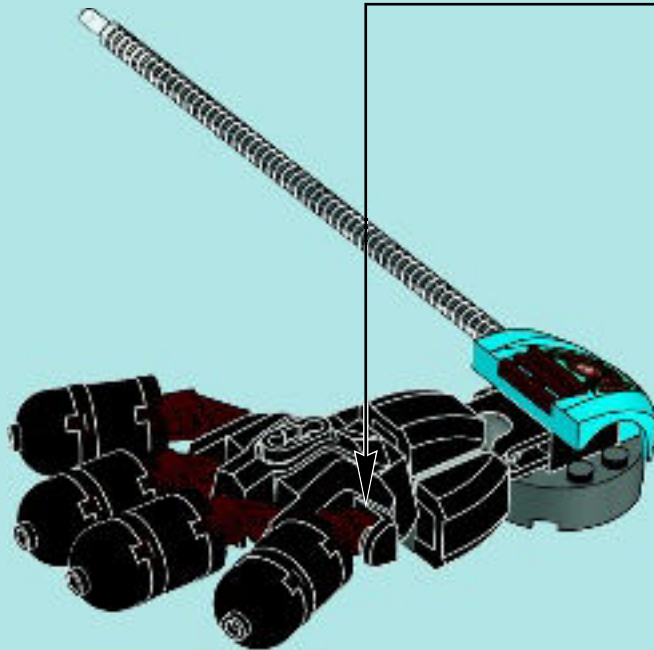

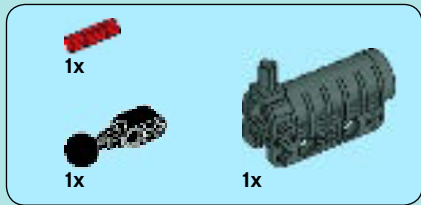

37

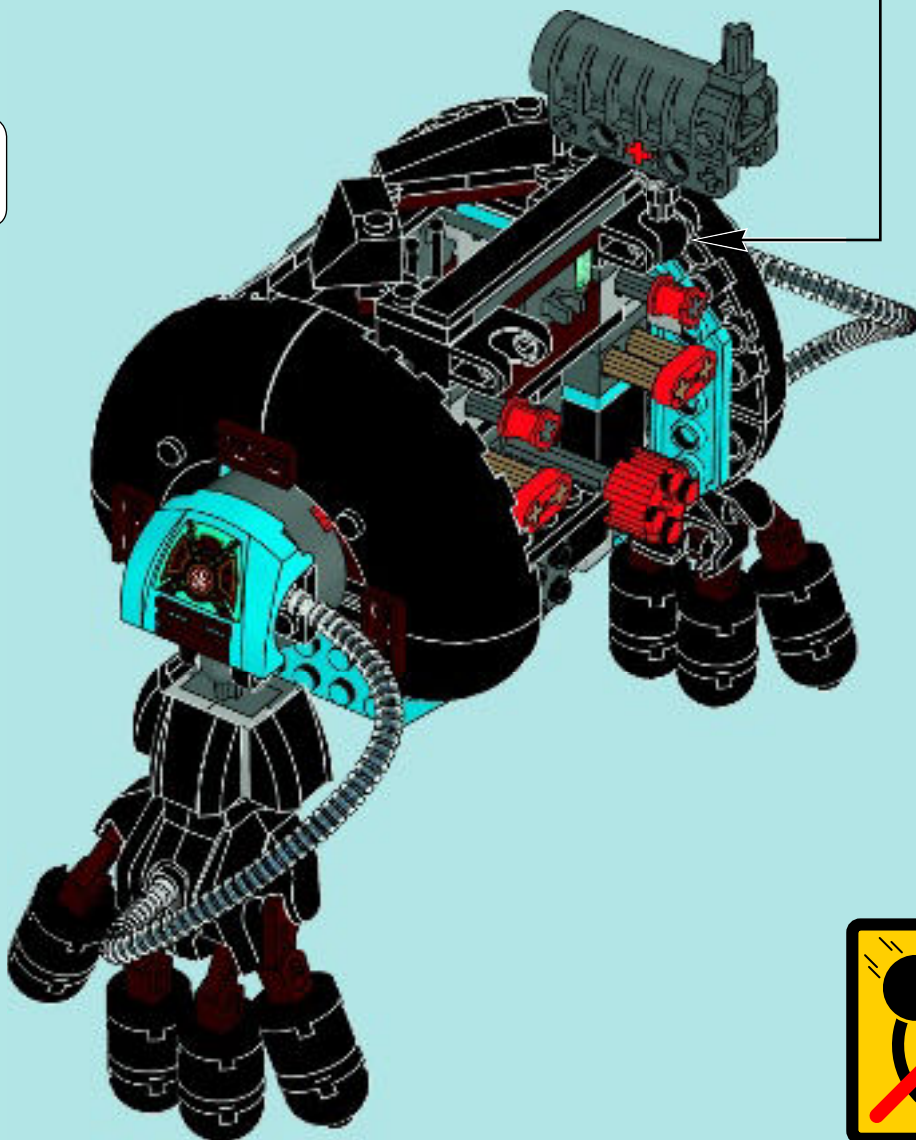
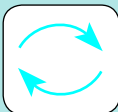
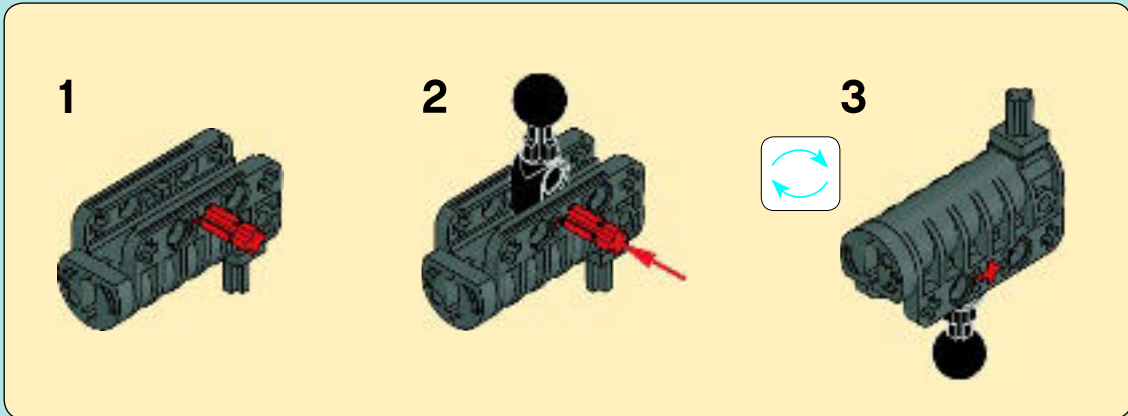

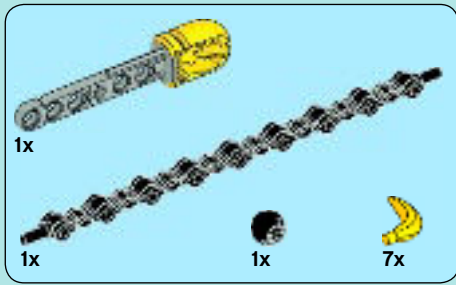

38

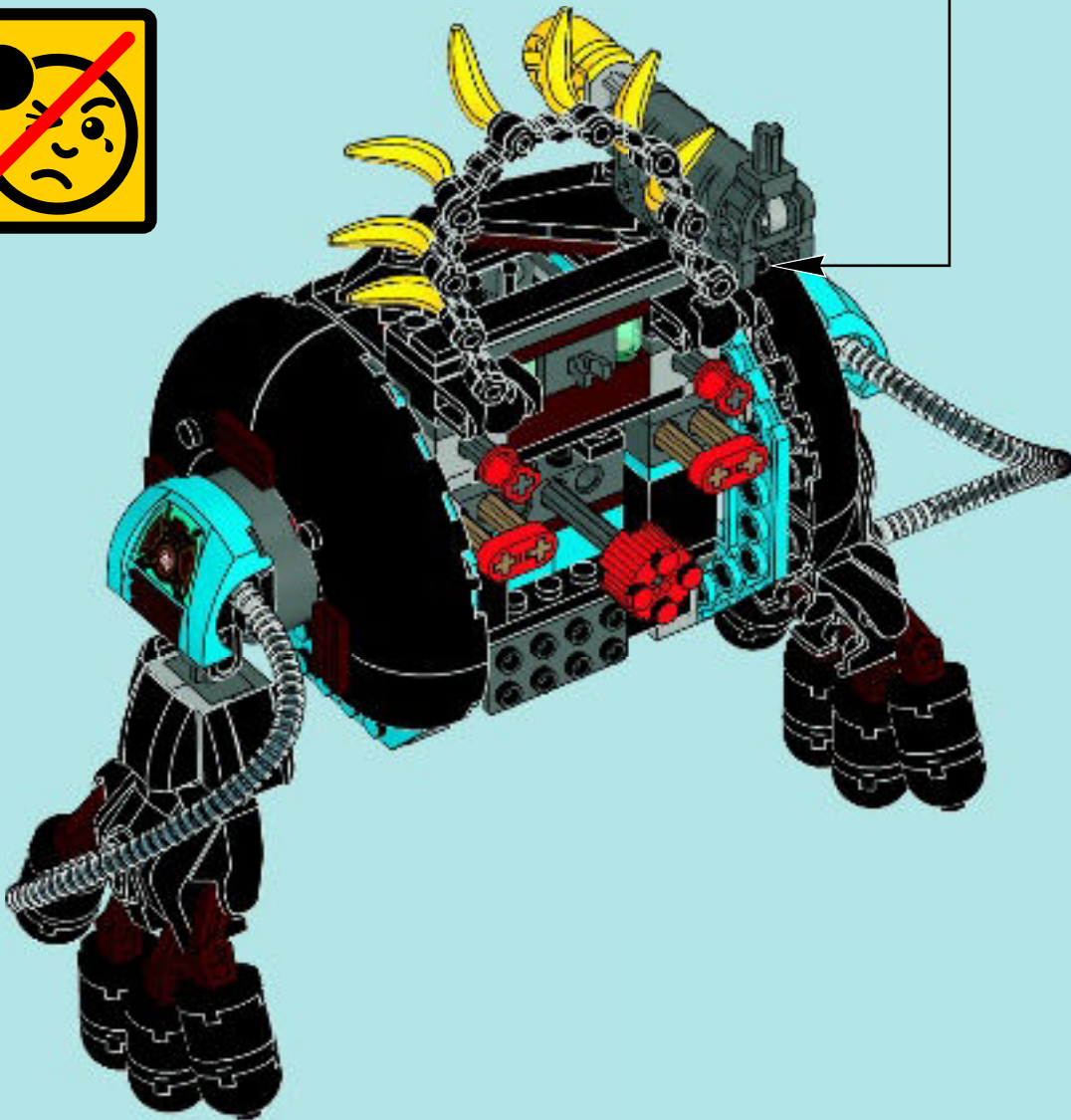
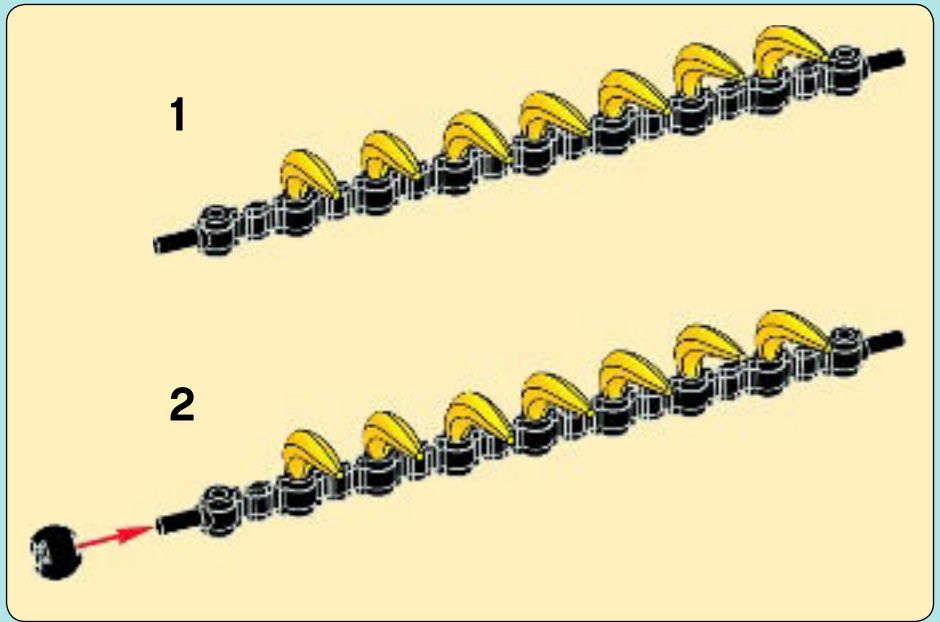

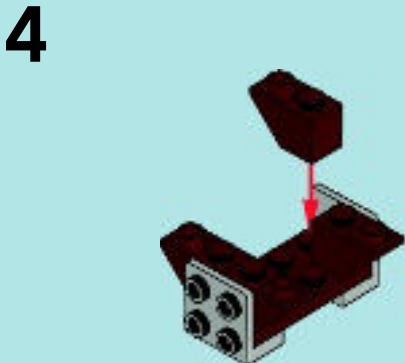
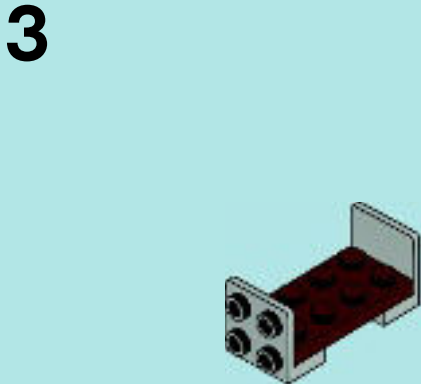
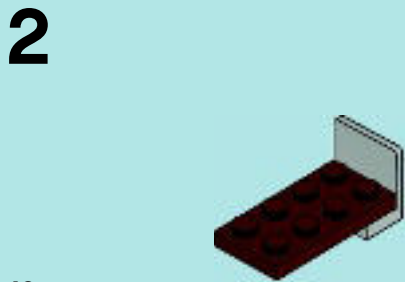
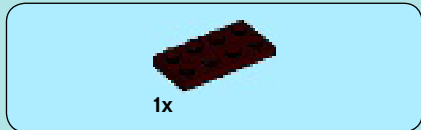
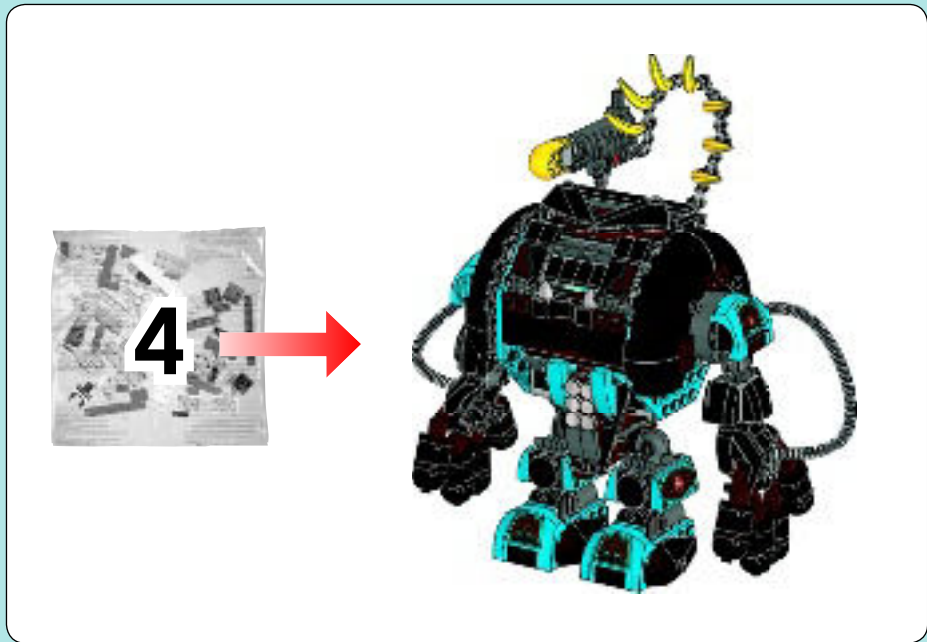



5

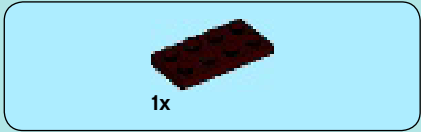

6

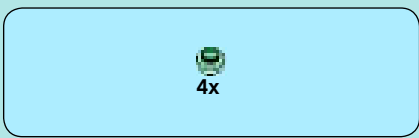

7

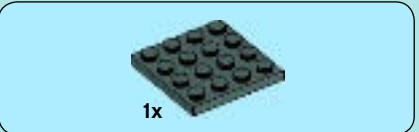

8





9



10



11



12

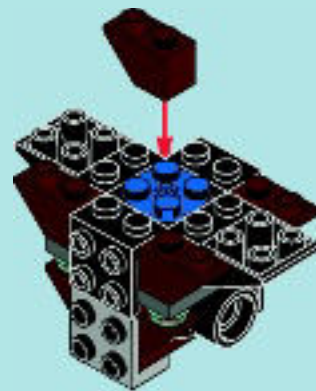



13

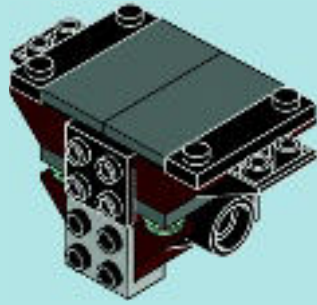

39

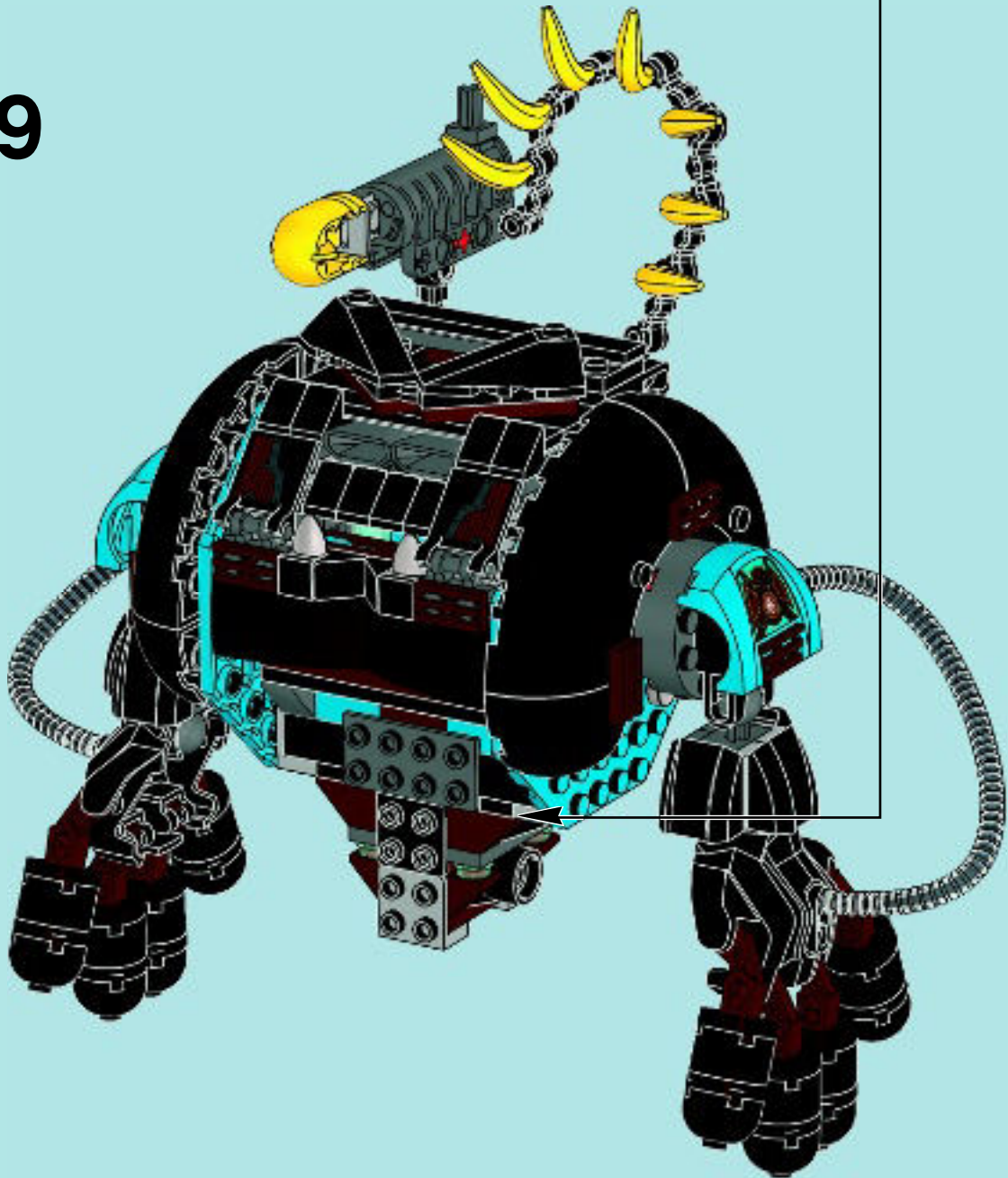

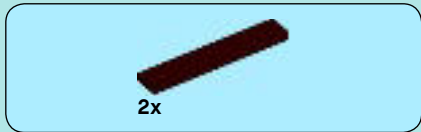

40

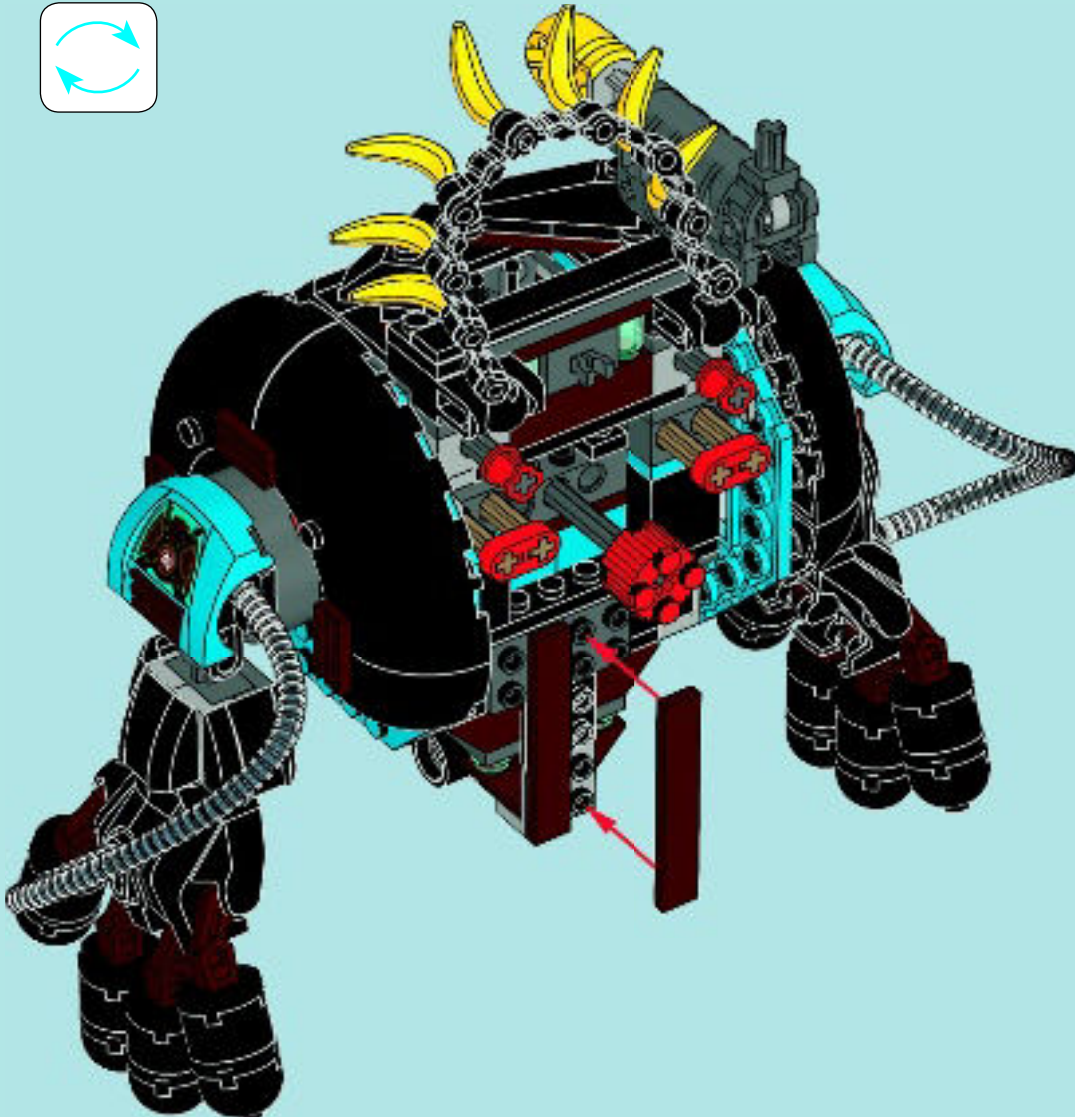
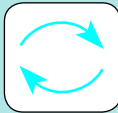

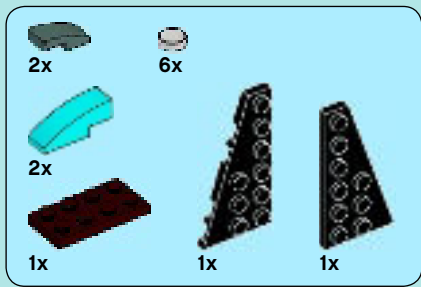

41

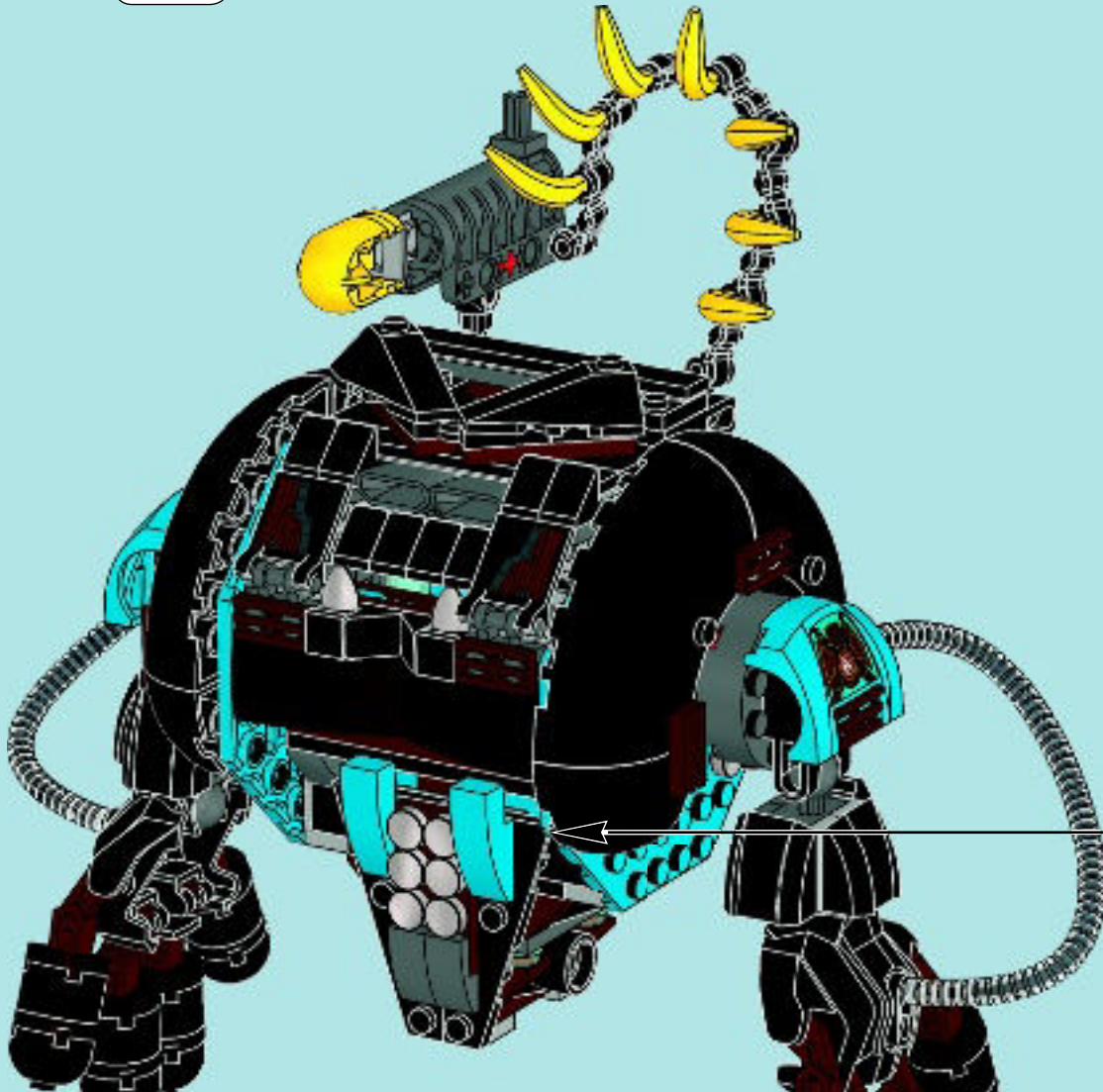
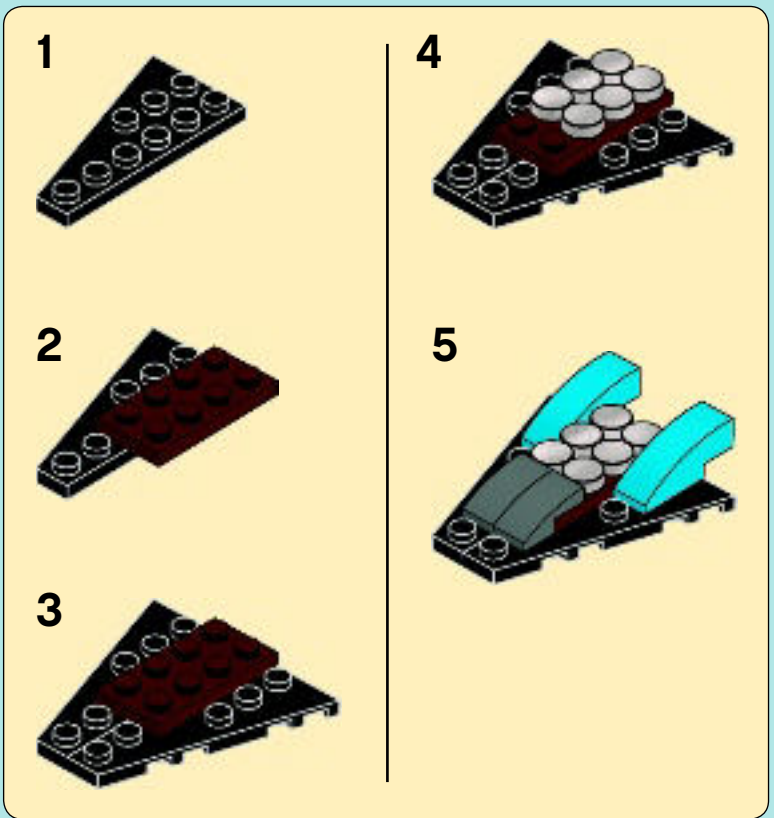
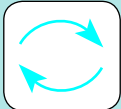

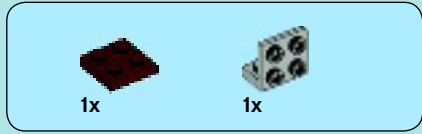

1

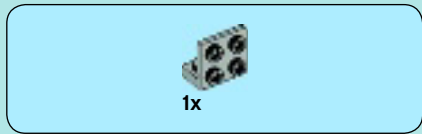
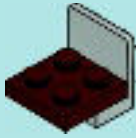

2



3

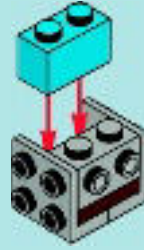

4





5



6

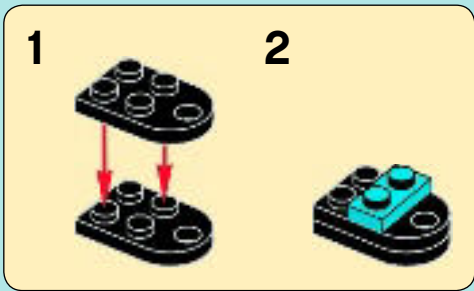

7



8





9

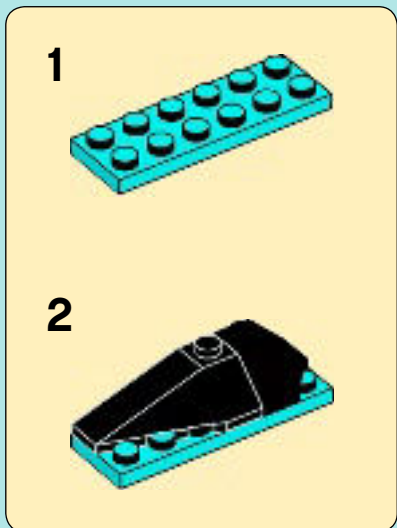

10

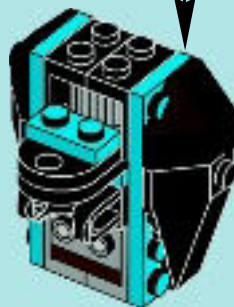
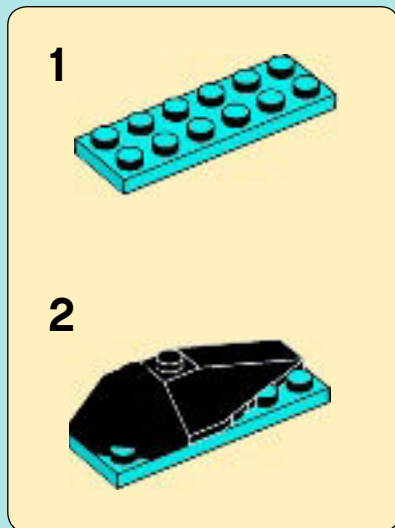

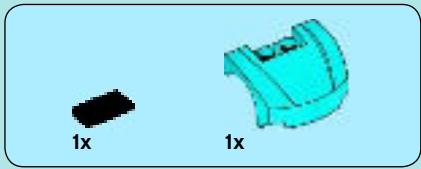

11

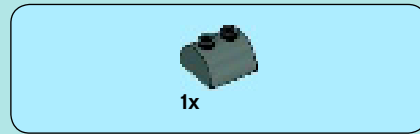

13

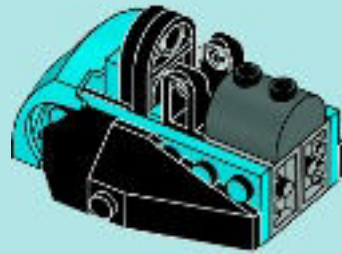
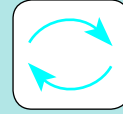

12

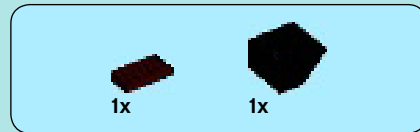

14

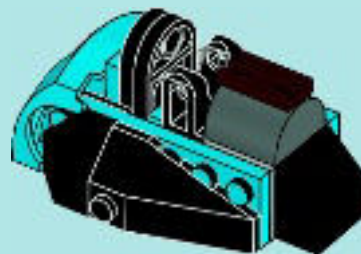



1

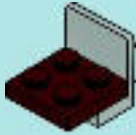

2

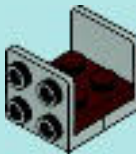

3

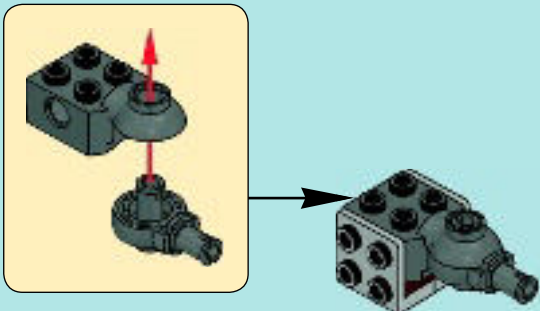

4



5

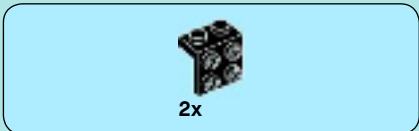

6

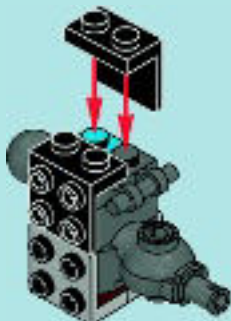



7

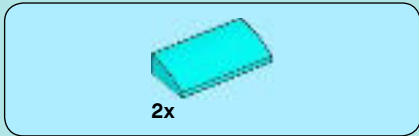
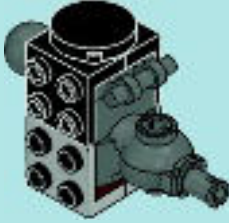

8

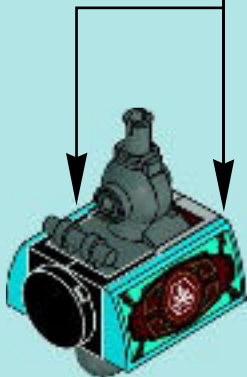
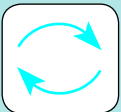
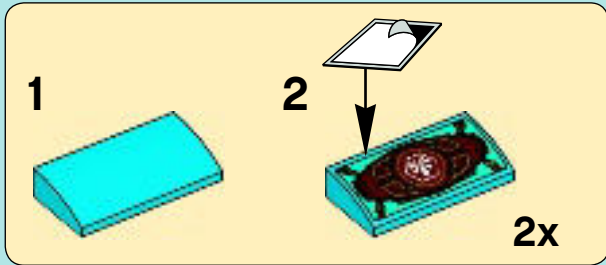

15

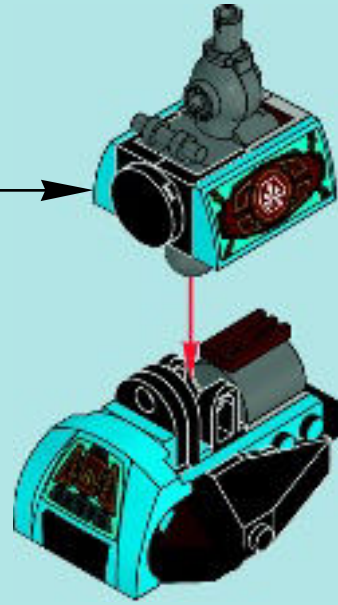

2x

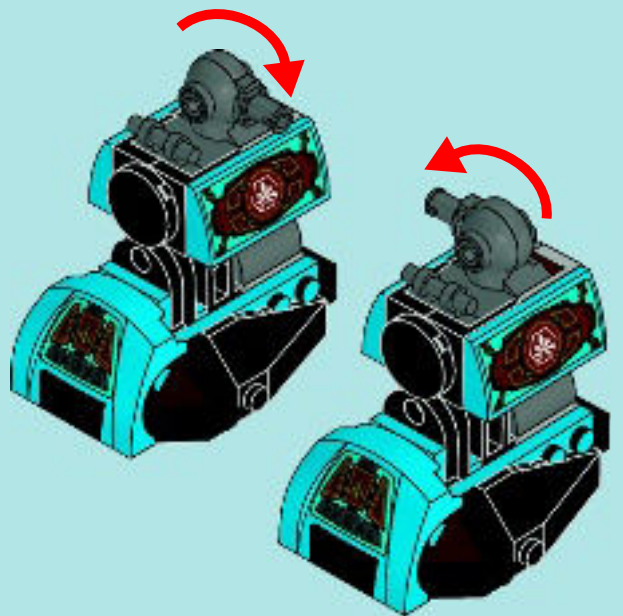

42

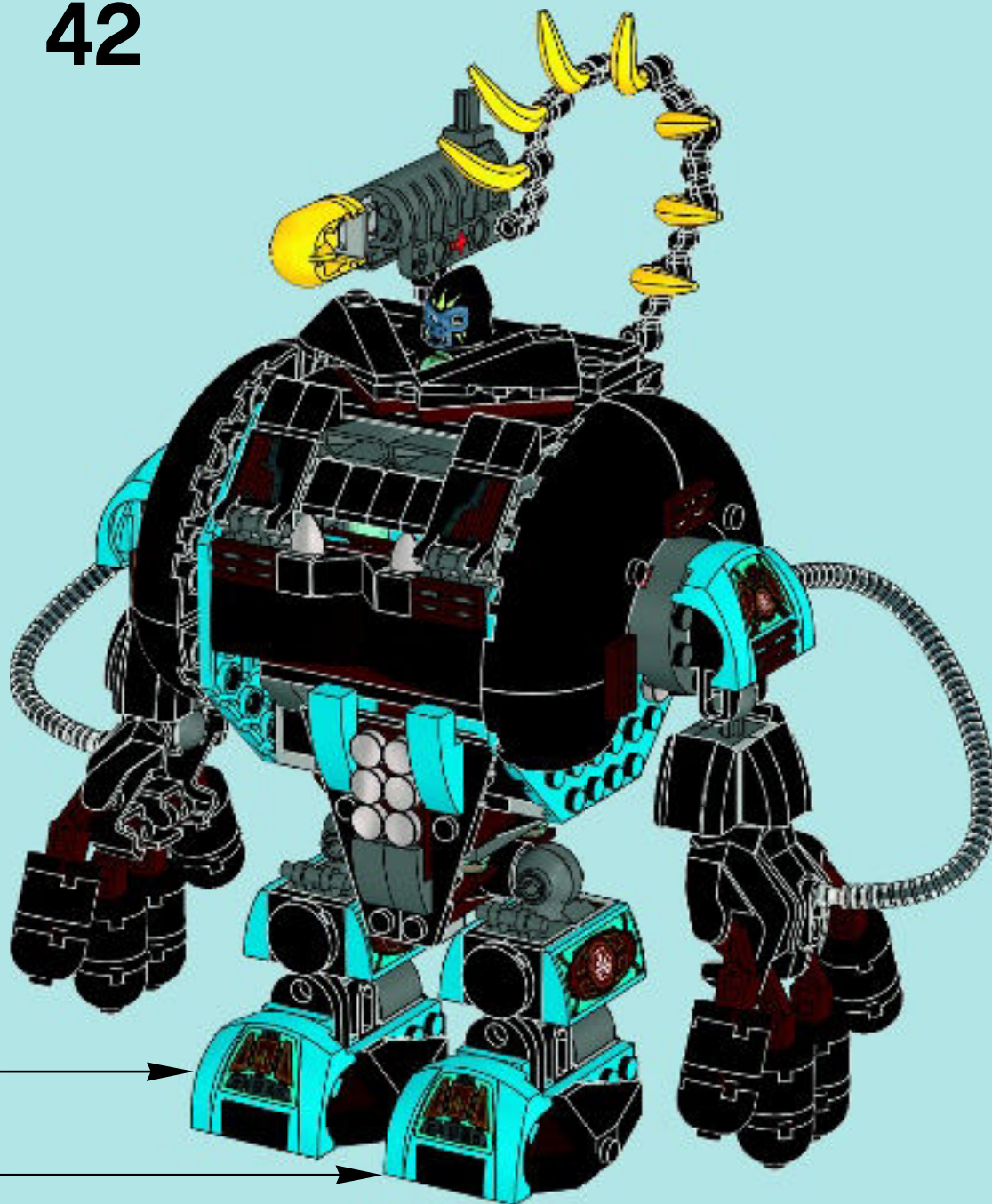



2x
4565452

5x
4650646

1x
4560179

2x
4186678

2x
4227155

1x
4142865

2x
4513174

1x
306823

4x
6009460

1x
403223

2x
4296152

7x
4114584

2x
6037390

6x
4619763

1x
4275826

8x
4216660

8x
614326

4x
4609397

4x
6025219

2x
370126

14x
4653087

2x
4273703

4x
6007896

2x
374726

3x
6040298

3x
6040297

2x
4599499

1x
395826

1x
303626

3x
6030718

2x
307026

2x
415026

4x
4598528

1x
4515340

10x
6048856

1x
6020193

2x
4556158

4x
4107761

2x
306826

4x
317626

3x
74011

2x
416226

1x
4283047

1x
4283046

1x
4515350

2x
6011815

1x
6024850

1x
6037625

1x
6022564

1x
6035319

1x
6035176

1x
6022509

1x
6022292

1x
6035141

1x
4537551

1x
4598897

2x
4563477

2x
6015899

2x
6018304

6x
4143875

1x
4517986

1x
4500902

4x
4290713

1x
4286267

1x
4560108

2x
4652375

3x
370626

1x
4652060

4x
4119479

1x
4507311

2x
3005741

2x
4124108

1x
6024904

4x
4183544

3x
6022171

12x
4163917

1x
6019570

6x
4497952

1x
4654448

4x
6031821

2x
6024916

2x
6021978

1x
4211225

2x
4216615

1x
4263776

8x
4211222

2x
4216625







2x
4614561

6

- 1x 4219726
- 4x 4216695
- 8x 4211190
- 8x 4211186
- 1x 4211211
- 1x 4225700
- 13x 4224243
- 2x 4211204
- 2x 4211219
- 10x 4262974
- 8x 6006740
- 2x 6015344
- 2x 4650645
- 4x 4211440
- 2x 4211410
- 2x 4211429
- 2x 4211396
- 1x 4211395
- 1x 4211814
- 14x 4654580
- 4x 4654582
- 1x 4211376
- 4x 6014615
- 1x 4258308
- 6x 4520320
- 3x 4211807
- 1x 6043056
- 1x 4265794
- 2x 4497253
- 2x 4210725
- 2x 4227395
- 2x 4498096
- 2x 4294180
- 2x 4558959
- 4x 4210762
- 1x 4213607
- 1x 4552203
- 2x 6029948
- 2x 4211093
- 2x 4598769
- 1x 4211056
- 1x 4243831
- 4x 4211002
- 1x 4210763
- 4x 6000606
- 4x 4210660
- 2x 4568734
- 4x 4648067
- 2x 4560184
- 1x 6037691
- 1x 6035318
- 1x 6035175
- 1x 6035135
- 2x 4502068
- 1x 4218696
- 2x 4522784
- 2x 4560177
- 2x 4560177
- 1x 4508553
- 1x 4518308
- 2x 4648296
- 4x 6034202
- 2x 6032854
- 2x 4566688
- 16x 4623298
- 1x 6035317
- 1x 6037419
- 1x 6035087
- 1x 6005225
- 2x 6035093
- 1x 4568951
- 10x 4655241
- 2x 6037878
- 2x 6037408
- 1x 6029660
- 2x 4625146
- 4x 6004943
- 5x 4655172
- 2x 4640901
- 19x 4653988
- 4x 4640891
- 4x 6036880
- 4x 4653722
- 2x 6038284
- 2x 6031787



Customer Service
Kundenservice
Service Consommateurs
Servicio Al Consumidor
LEGO.com/service or dial

00800 5346 5555 :          

1-800-422-5346 :  



LEGENDS OF
CHIMATM

IB70008-62



**USE THE ONLINE CODE TO
UNLOCK YOUR REWARD
GIB DEN ONLINE-CODE EIN,
UM DEINE BELOHNUNG
FREIZUSCHALTEN**

**UTILISE LE CODE EN LIGNE
POUR DÉBLOQUER TA
RÉCOMPENSE**

**USA EL CÓDIGO EN
INTERNET PARA
DESBLOQUEAR TU
RECOMPENSA**

**USA O CÓDIGO ONLINE
PARA DESBLOQUEARES O
TEU PRÉMIO**

**HASZNÁLD AZ ONLINE
KÓDOT, HOGY MEGKAPD
A JUTALMAD**

LEGO.COM/CHIMA



LEGENDS OF
CHIMATM

70203

70200

70010

70115

70009

LEGO.COM/CHIMA





70010



70009



70008



70007



70200



70201



70202



70203



70204



70205



70108



70109



70114



70115



50006



LEGENDS OF CHIMA™



7+



LEGO, the LEGO logo and LEGENDS OF CHIMA are trademarks of the LEGO Group. ©2013 The LEGO Group.



club™

Free*! Gratuit!

* Paid subscription in Australia and New Zealand.
Abonnement payant en Australie et Nouvelle-Zélande



© 2013 The LEGO Group.



LEGO.com/club



WIN!

Go to www.LEGOsurvey.com/product to fill out a survey for a chance to win a cool LEGO® Product.

No purchase necessary.

Open to all residents where not prohibited.



www.LEGOsurvey.com/product

GEWINNE!

Nimm an der Umfrage auf www.LEGOsurvey.com/product teil und hab die Chance ein cooles LEGO® Produkt zu gewinnen!

Die Teilnahme am Gewinnspiel führt zu keinerlei Kaufverpflichtungen. Teilnahme in allen nicht ausgeschlossenen Ländern möglich.

WIN!

Ga naar www.LEGOsurvey.com/product, vul een enquêteformulier in en maak kans op een cool LEGO® product.

Geen aankoopverplichting. Iedereen mag deelnemen, uitgezonderd ingezetenden van landen waar een enquêteverbod geldt.

GAGNE!

Visite www.LEGOsurvey.com/product pour répondre à un questionnaire et avoir une chance de gagner un produit LEGO® très cool!

Aucune obligation d'achat. Ouvert à tous les résidents des pays autorisés.

当てよう!

www.LEGOsurvey.com/product にアクセスして、アンケートにご記入ください。当選者にはレゴ製品を差し上げます。

お買い上げの必要はありません。禁止されていない限り、すべての皆様にご利用いただけます。



LEGO.com

6050707

LEGO, the LEGO logo and LEGENDS OF CHIMA are trademarks of the LEGO Group.
©2013 The LEGO Group.